











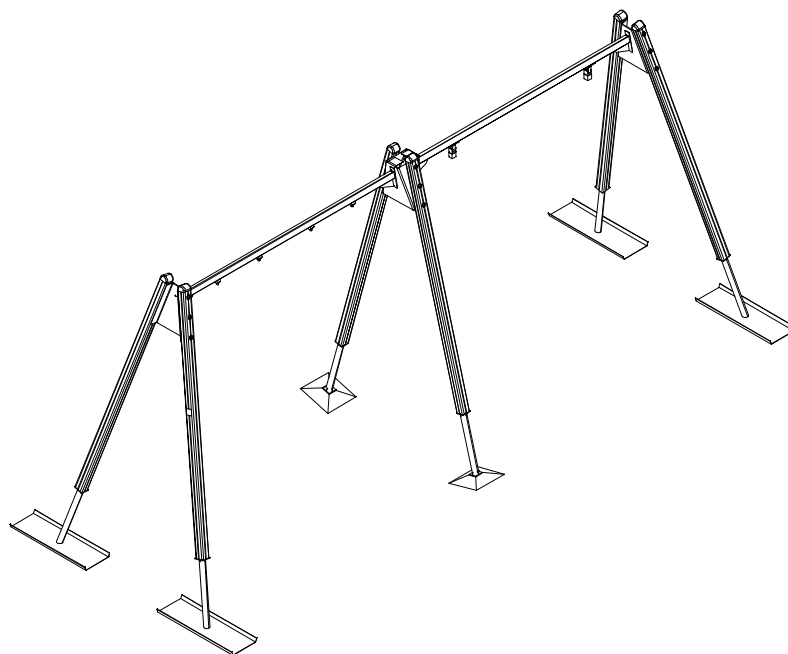

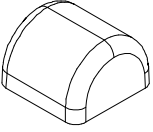



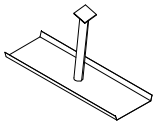

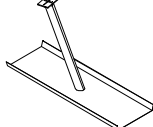
PRIME

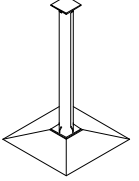
ASENNUSOHJE
MONTERINGSANSVISNING
INSTALLATION INSTRUCTION
AUFBAUANLEITUNG
NOTICE D'INSTALLATION

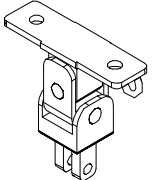
DATE: 14.1.2026

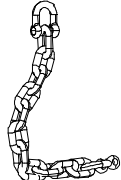
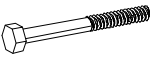
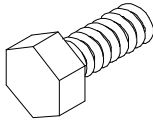
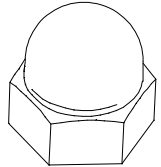
F24400M

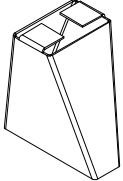

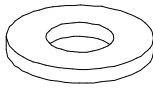
712101-001  L 2650	PCS 6	712788  	PCS 6	712797  	PCS 1	713047  	PCS 2	713048  	PCS 2	713253  	PCS 2
900965  M10	PCS 8	901958 	PCS 2	902234  M12	PCS 4	903149  M12x30	PCS 8	903577 	PCS 2	904904 	PCS 4
905087  Ø45x17	PCS 18	906499  M12x110	PCS 4	909110  M12x120	PCS 18	909638  M10 20/10,5	PCS 16	909639  M10x25	PCS 8	909644  M12	PCS 26
914223  6x503x547	PCS 2	914227  L2943	PCS 1	914231  	PCS 1	914232  L2940	PCS 1	980154  M12 13/24	PCS 42		PCS
	PCS		PCS		PCS		PCS		PCS		PCS
	PCS		PCS		PCS		PCS		PCS		PCS
	PCS		PCS		PCS		PCS		PCS		PCS

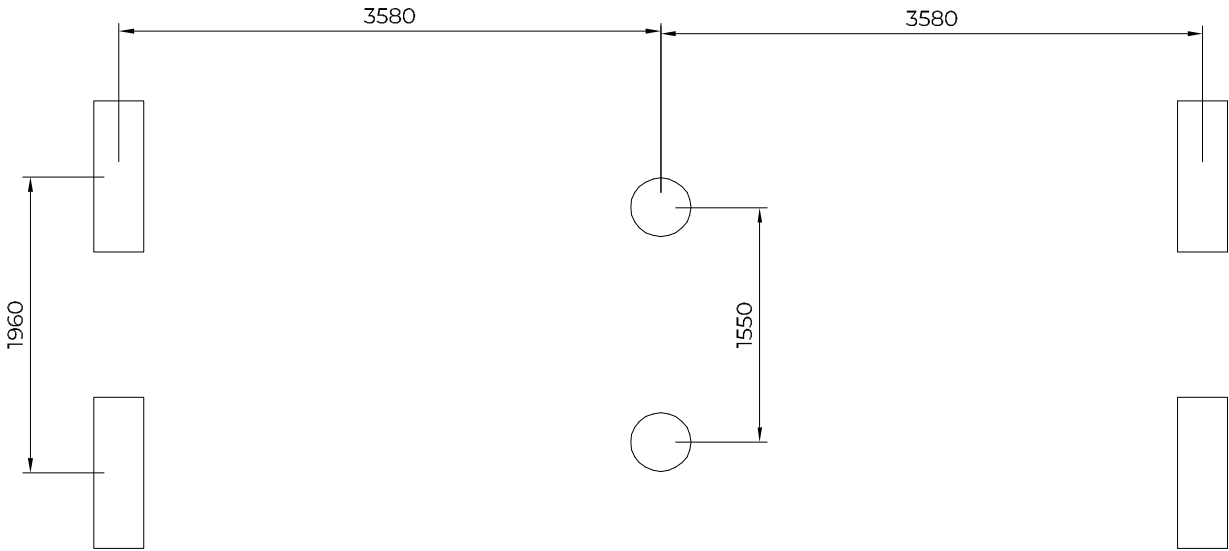
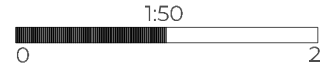

—— EN/AS Impact Area 45 m²
- - - - Falling Space 45 m²
Max Falling Height 1400 mm

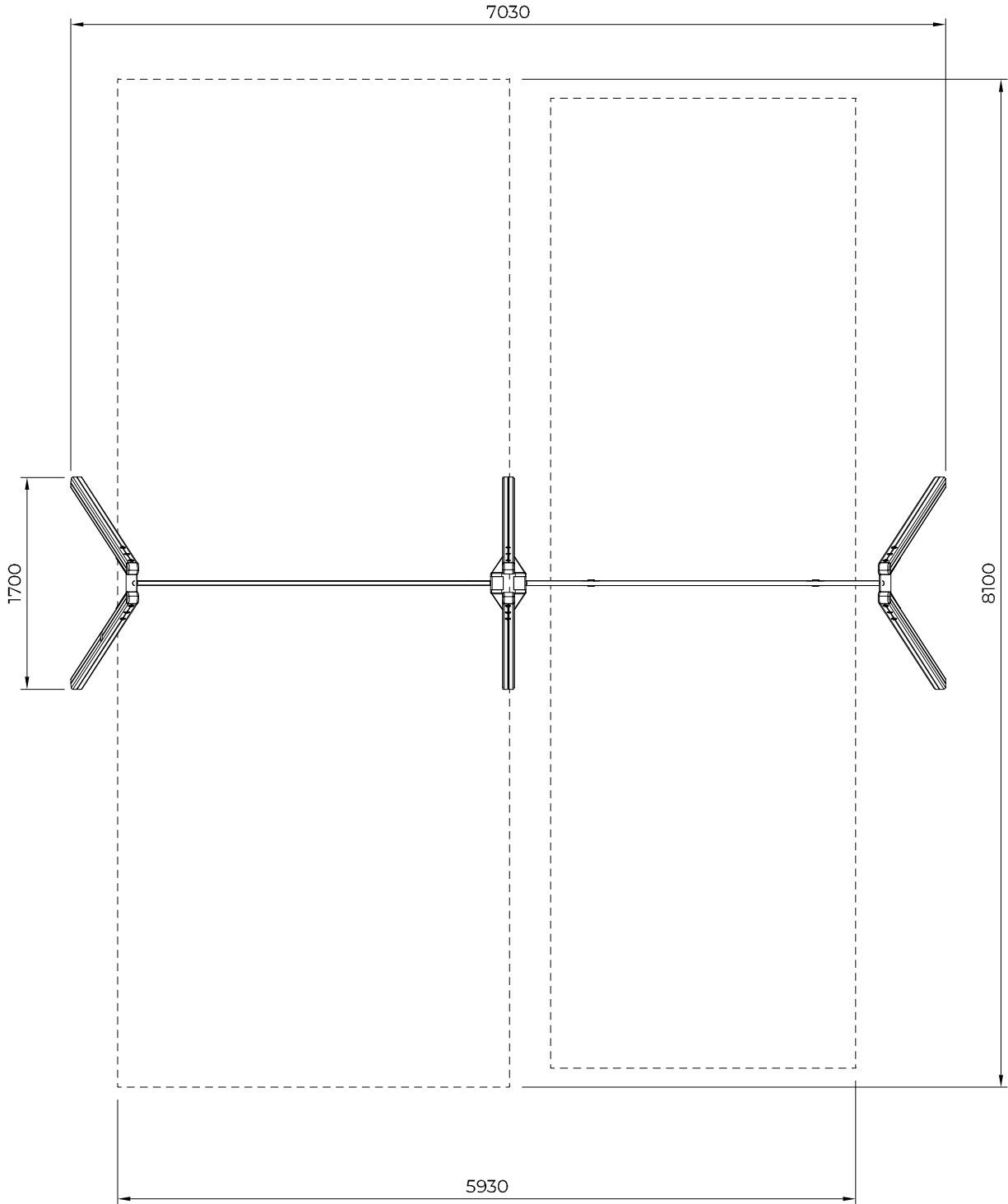
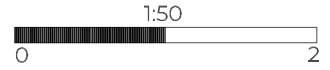

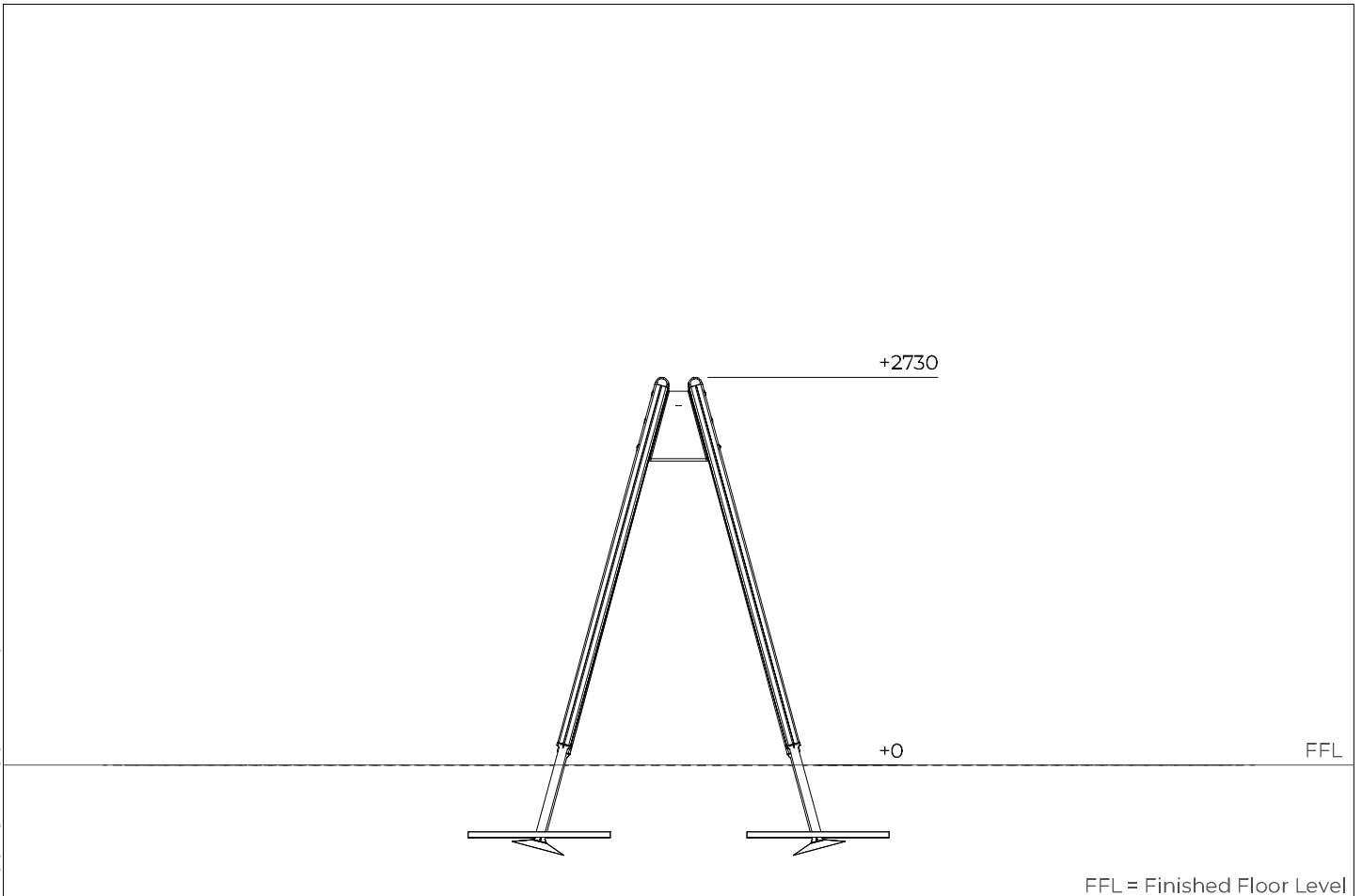
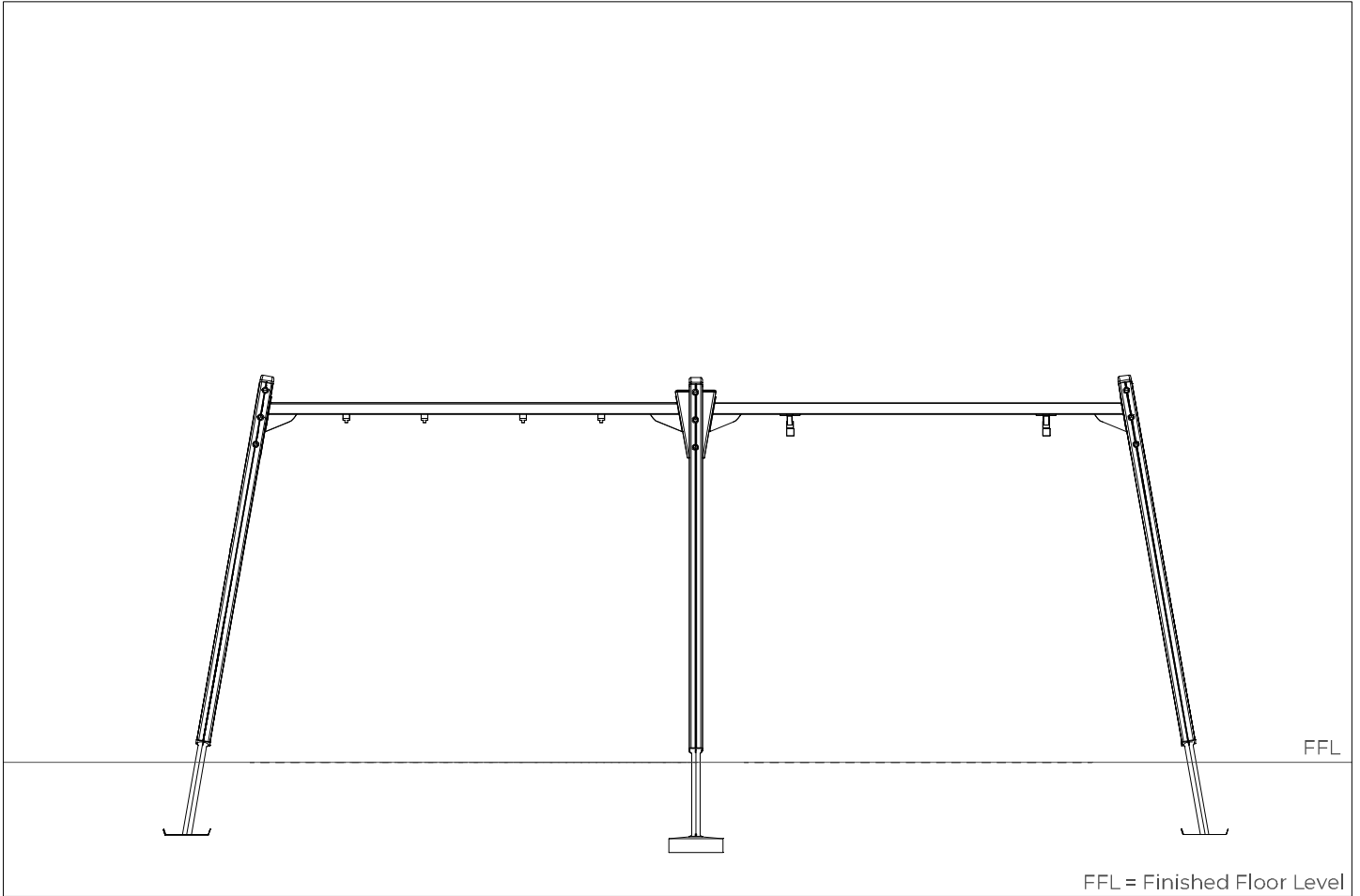

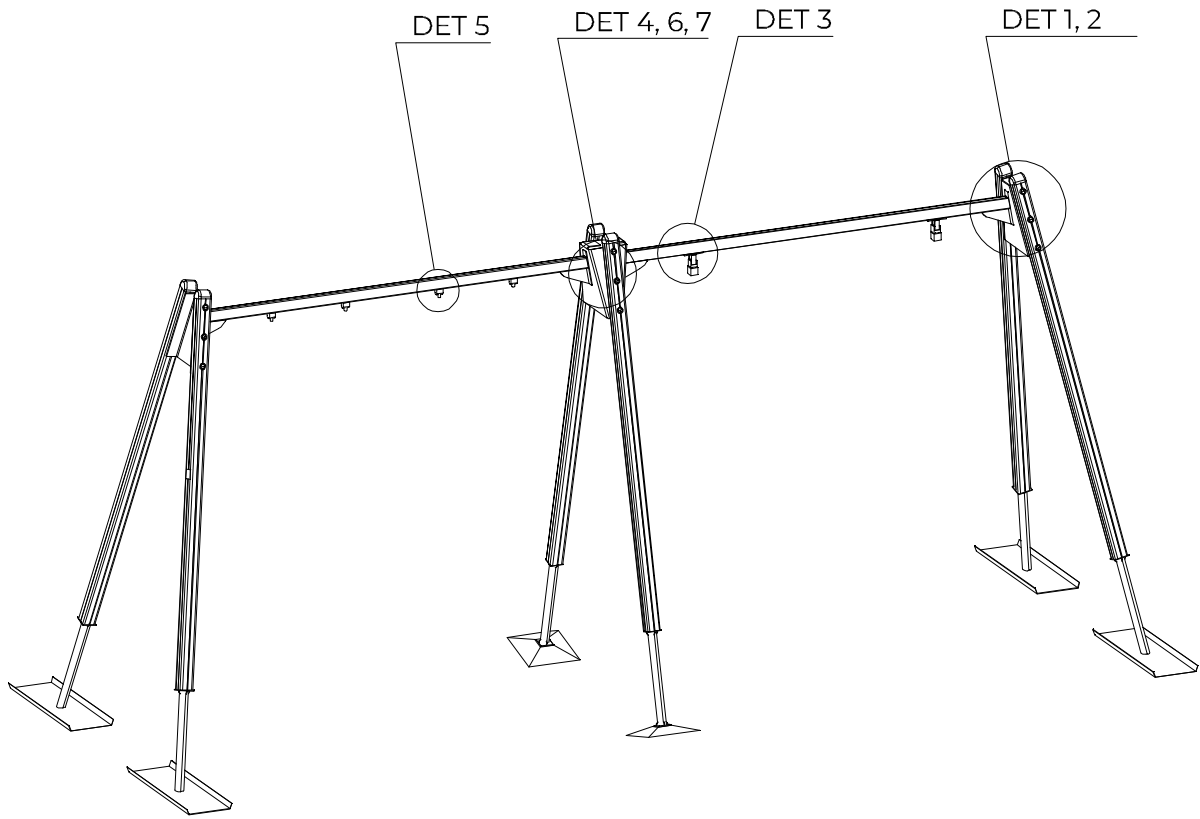

<p>DET 1</p> <p>M12x30 (903149) $\varnothing 24/13$ (980154) 80Nm (M12) (909644) 45Nm (M10) (900965) $\varnothing 20/10.5$ (909638) M10x25 (909639)</p>	<p>DET 2</p> <p>M12x120 (909110) 905087 M12 (909644) $\varnothing 24/13$ (980154)</p>	<p>DET 3</p> <p>90Nm (M12) M12x110 (906499) $\varnothing 24/13$ (980154) 901958 $\varnothing 24/13$ (980154) M12 (902234) 903577 CUT EXTRA CHAIN</p>
<p>DET 4</p> <p>M12x30 (903149) $\varnothing 24/13$ (980154) 80Nm (M12) (909644) 45Nm (M10) (900965) $\varnothing 20/10.5$ (909638) M10x25 (909639)</p>	<p>DET 5</p> <p>90Nm M12 (902234) $\varnothing 24/13$ (980154) 904904</p>	<p>DET 6</p> <p>904317</p>
<p>DET 7</p> <p>914231 M12 (909644) $\varnothing 44.5$ (905087) M12x120 (909110) $\varnothing 24/13$ (980154)</p>		

