











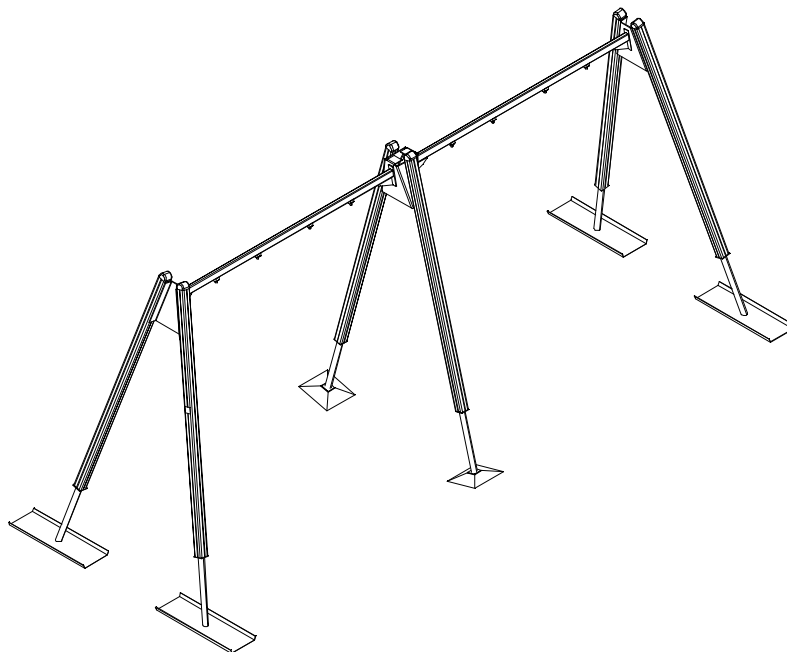



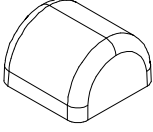

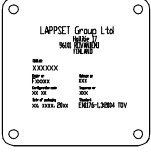

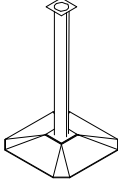

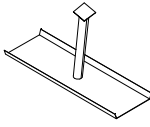
PRIME

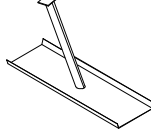
ASENNUSOHJE
MONTERINGSANSVISNING
INSTALLATION INSTRUCTION
AUFBAUANLEITUNG
NOTICE D'INSTALLATION

DATE: 19.12.2025

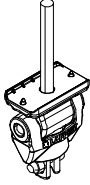
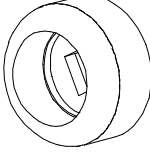
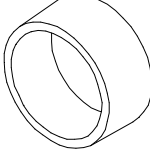
F24403M

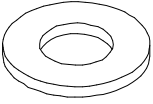
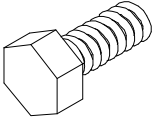
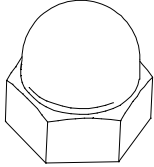
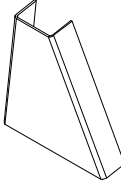
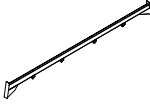
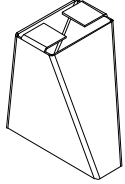

712098  L 2650	PCS 6	712788  	PCS 6	712797  	PCS 1	712889  L 700 	PCS 2	713045  	PCS 2	713046  	PCS 2
900965  M10	PCS 8	903149  M12x30	PCS 8	904904 	PCS 8	905090  Ø45	PCS 18	905115  Ø30	PCS 18	909347  M12x35	PCS 18
909638  M10 20/10,5	PCS 16	909639  M10x25	PCS 8	909644  M12	PCS 8	914223  6x503x547	PCS 2	914227  L2943	PCS 2	914231  	PCS 1
980154  M12 13/24	PCS 34		PCS		PCS		PCS		PCS		PCS
	PCS		PCS		PCS		PCS		PCS		PCS
	PCS		PCS		PCS		PCS		PCS		PCS

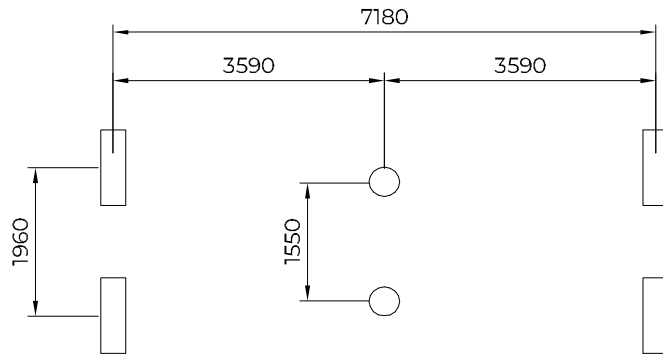

- EN/AS Impact Area 51 m²
- - - - Falling Space 51 m²
Max Falling Height 1400 mm

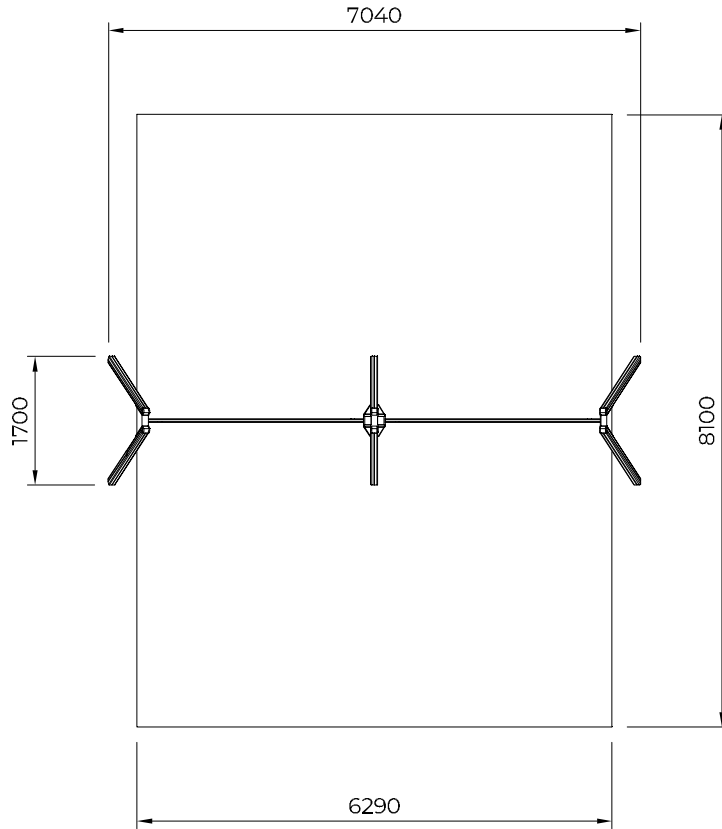

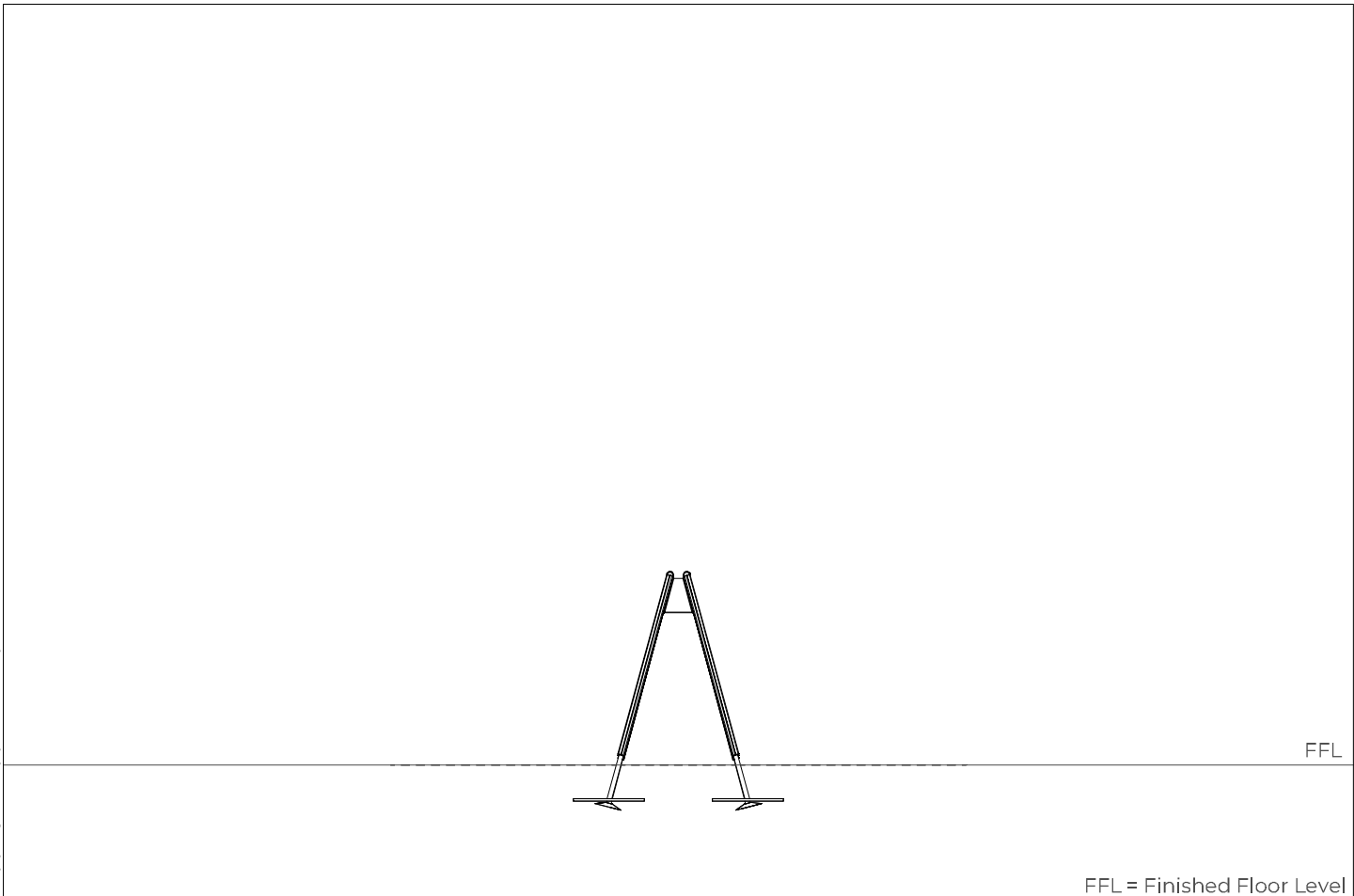
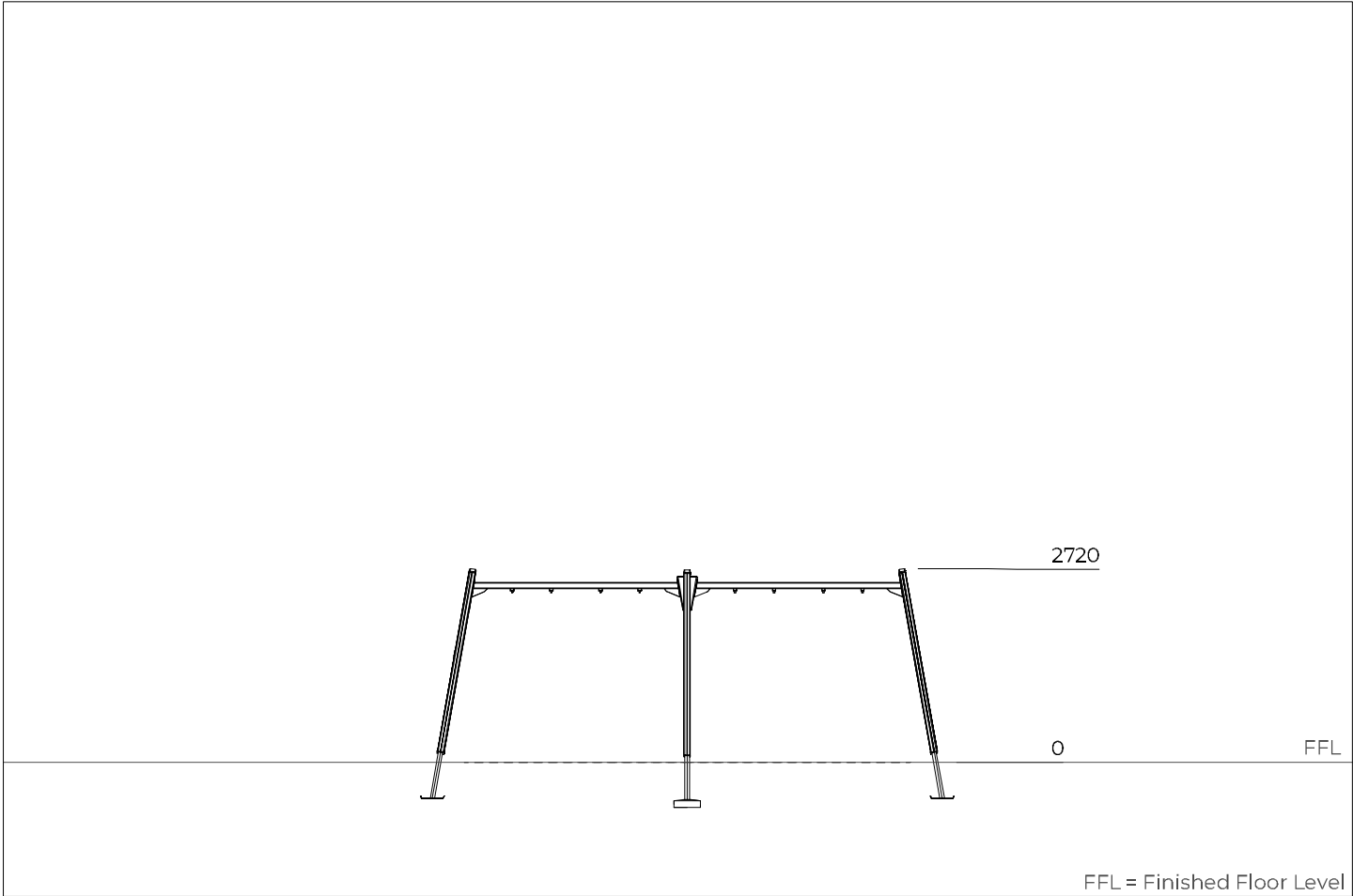

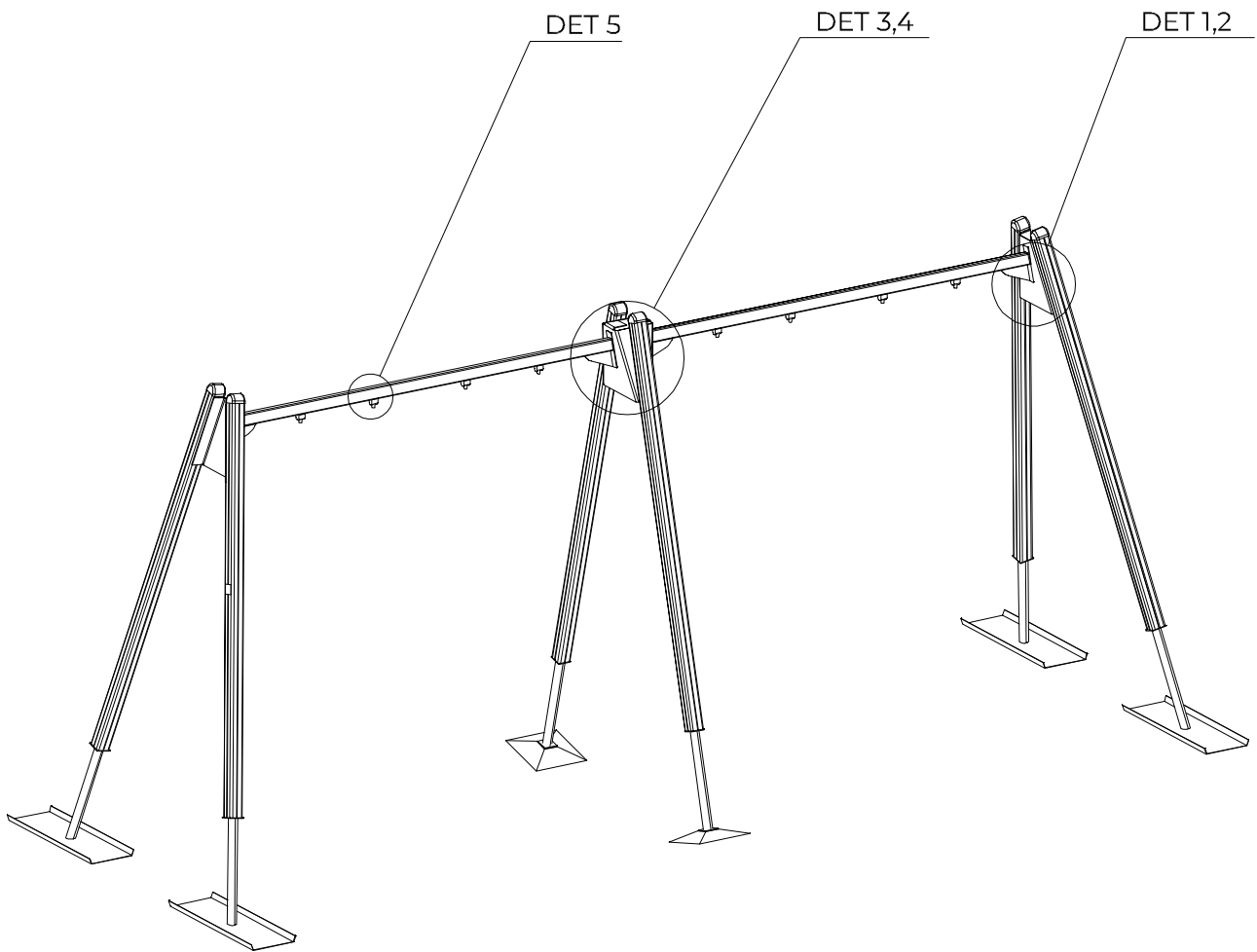

<p>DET 1</p> <p>M12x30 (903149) Ø24/13 (980154) 80Nm (M12) (909644) 45Nm (M10) (900965) Ø20/10.5 (909638) M10x25 (909639)</p>	<p>DET 2</p> <p>905090 Ø24/13 (980154) 999561 M12x35 (909347) 905115</p>	<p>DET 3</p> <p>M12x30 (903149) Ø24/13 (980154) 80Nm (M12) (909644) 45Nm (M10) (900965) Ø20/10.5 (909638) M10x25 (909639)</p>
<p>DET 4</p> <p>905090 Ø24/13 (980154) M12x35 (909347) 999561</p>	<p>DET 5</p> <p>90Nm M12 (902234) Ø24/13 (980154) 904904</p>	

