











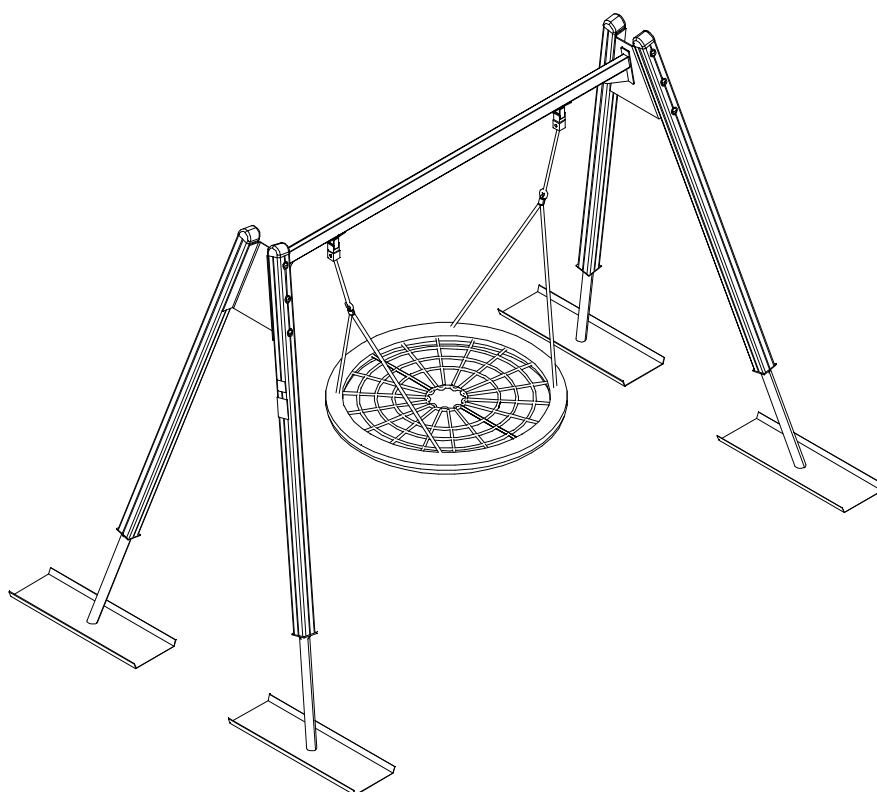



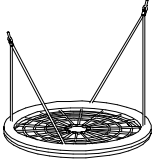

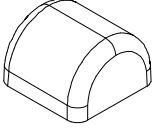

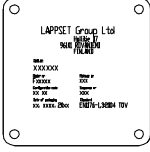

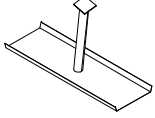

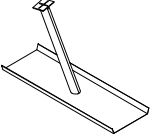
PRIME

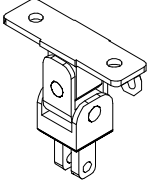
ASENNUSOHJE  
MONTERINGSANSVISNING  
INSTALLATION INSTRUCTION  
AUFBAUANLEITUNG  
NOTICE D'INSTALLATION

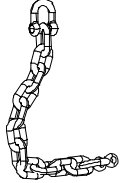
DATE: 19.12.2025

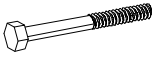
F24407M

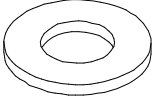
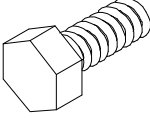
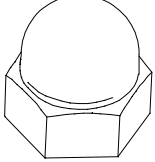
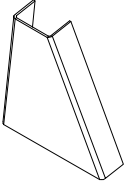
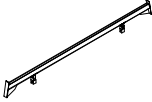
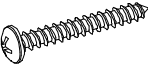

702533  118x78	PCS 1	706947 	PCS 1	712099-001  L 2250	PCS 4	712788  	PCS 4	712797  	PCS 1	713047  	PCS 2
713048  	PCS 2	900965  M10	PCS 4	901958 	PCS 2	902234  M12	PCS 4	903149  M12x30	PCS 4	903577 	PCS 2
905087  Ø45x17	PCS 12	906499  M12x110	PCS 4	909110  M12x120	PCS 12	909638  Ø20/10.5	PCS 8	909639  M10x25	PCS 4	909644  M12	PCS 16
914223-213  6x503x547	PCS 2	914232-213  L2940	PCS 1	980114  Ø4x20	PCS 4	980154  M12 13/24	PCS 28		PCS		PCS
	PCS		PCS		PCS		PCS		PCS		PCS
	PCS		PCS		PCS		PCS		PCS		PCS
	PCS		PCS		PCS		PCS		PCS		PCS

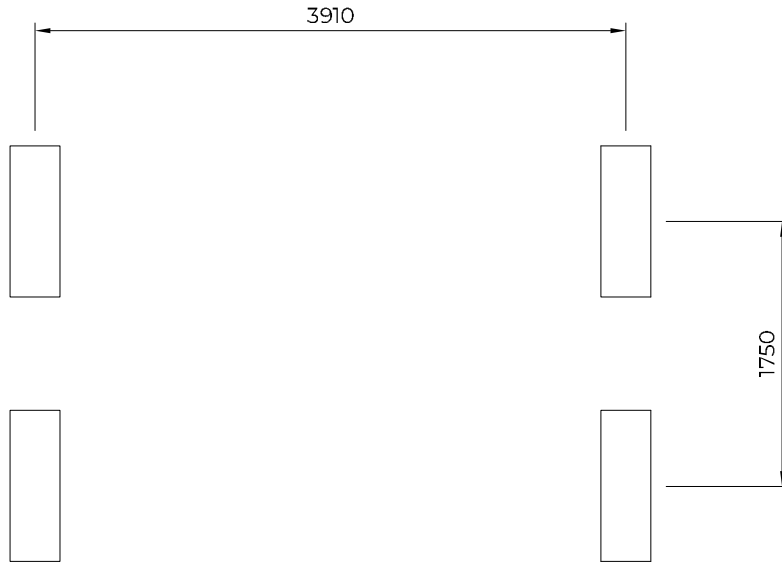
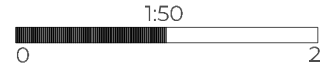

- EN/AS Impact Area 19 m<sup>2</sup>
- - - - Falling Space 19 m<sup>2</sup>  
Max Falling Height 1200 mm

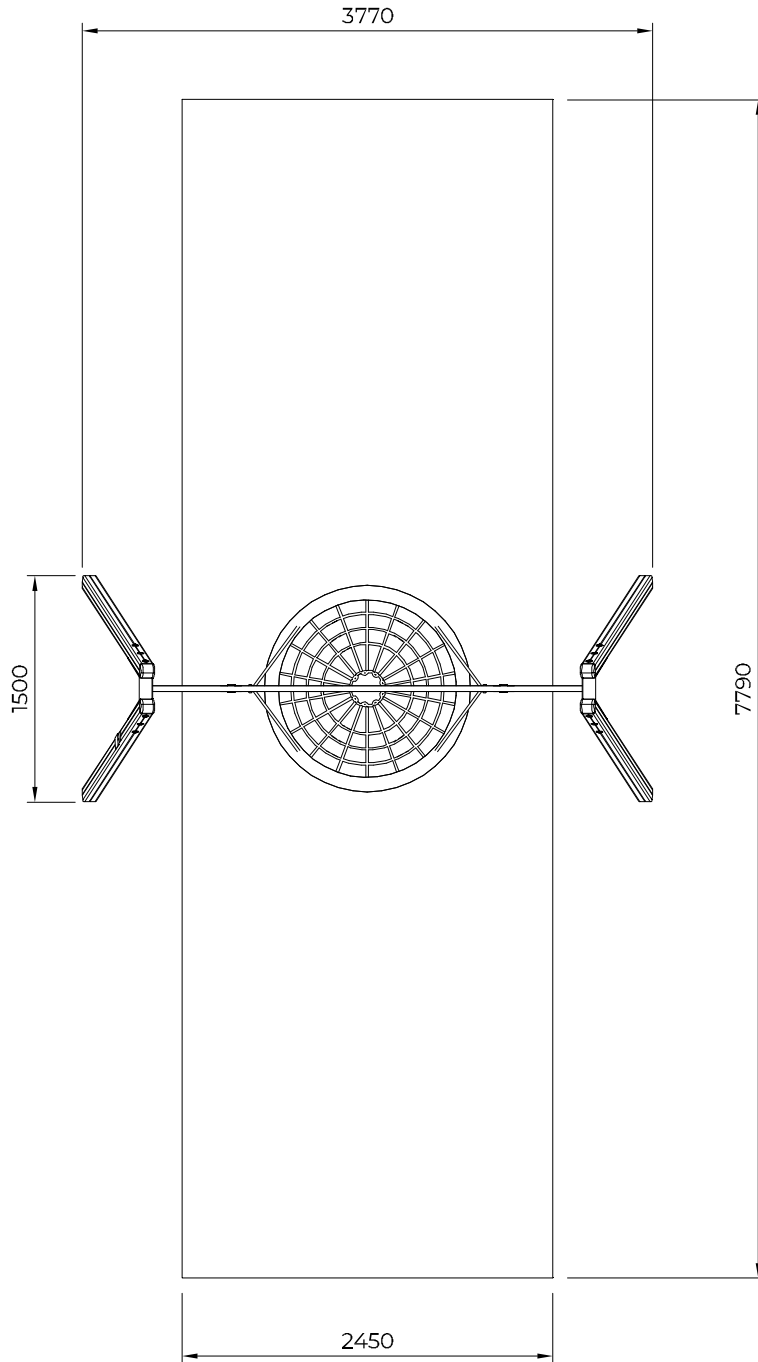
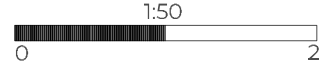

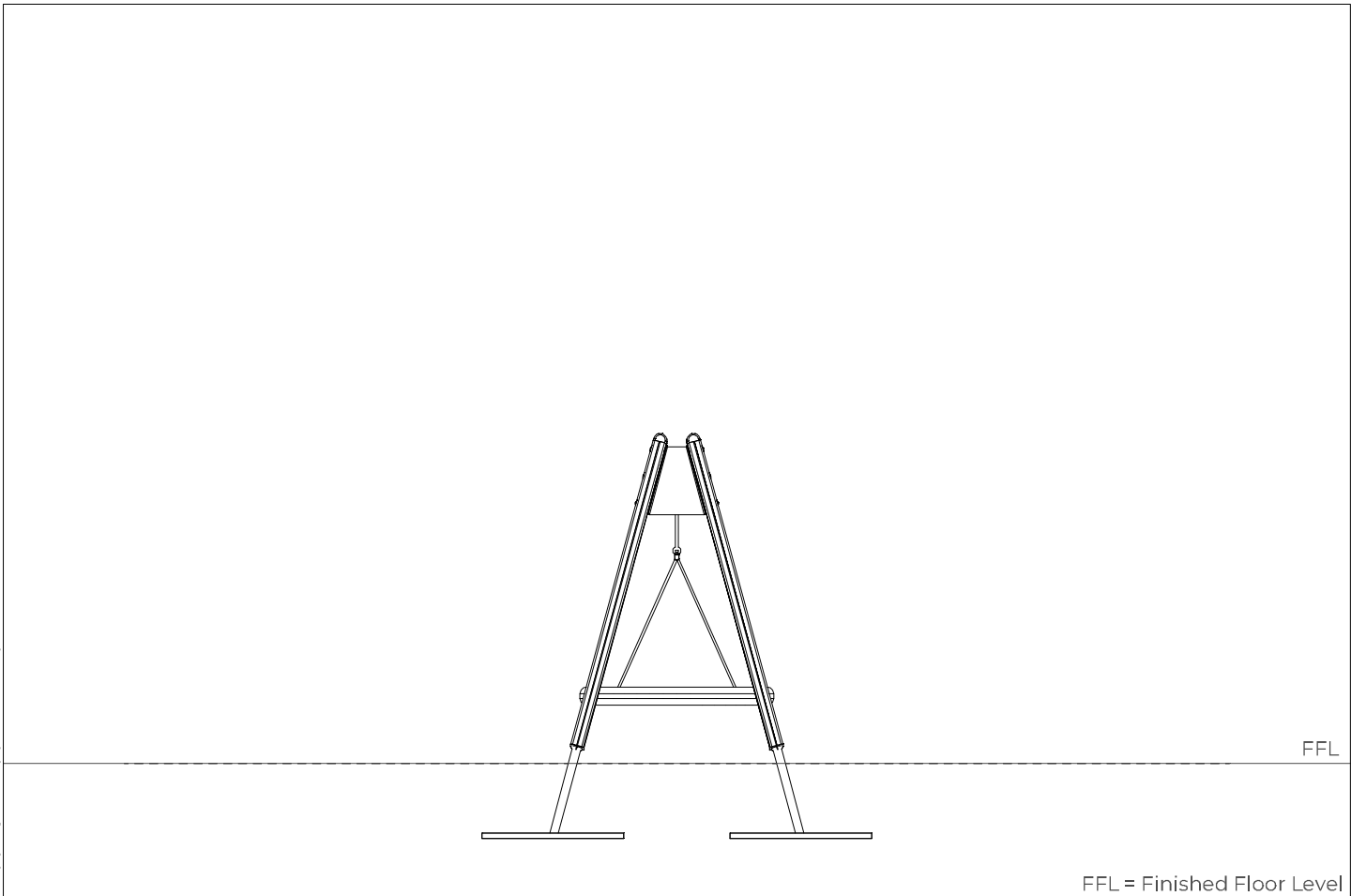
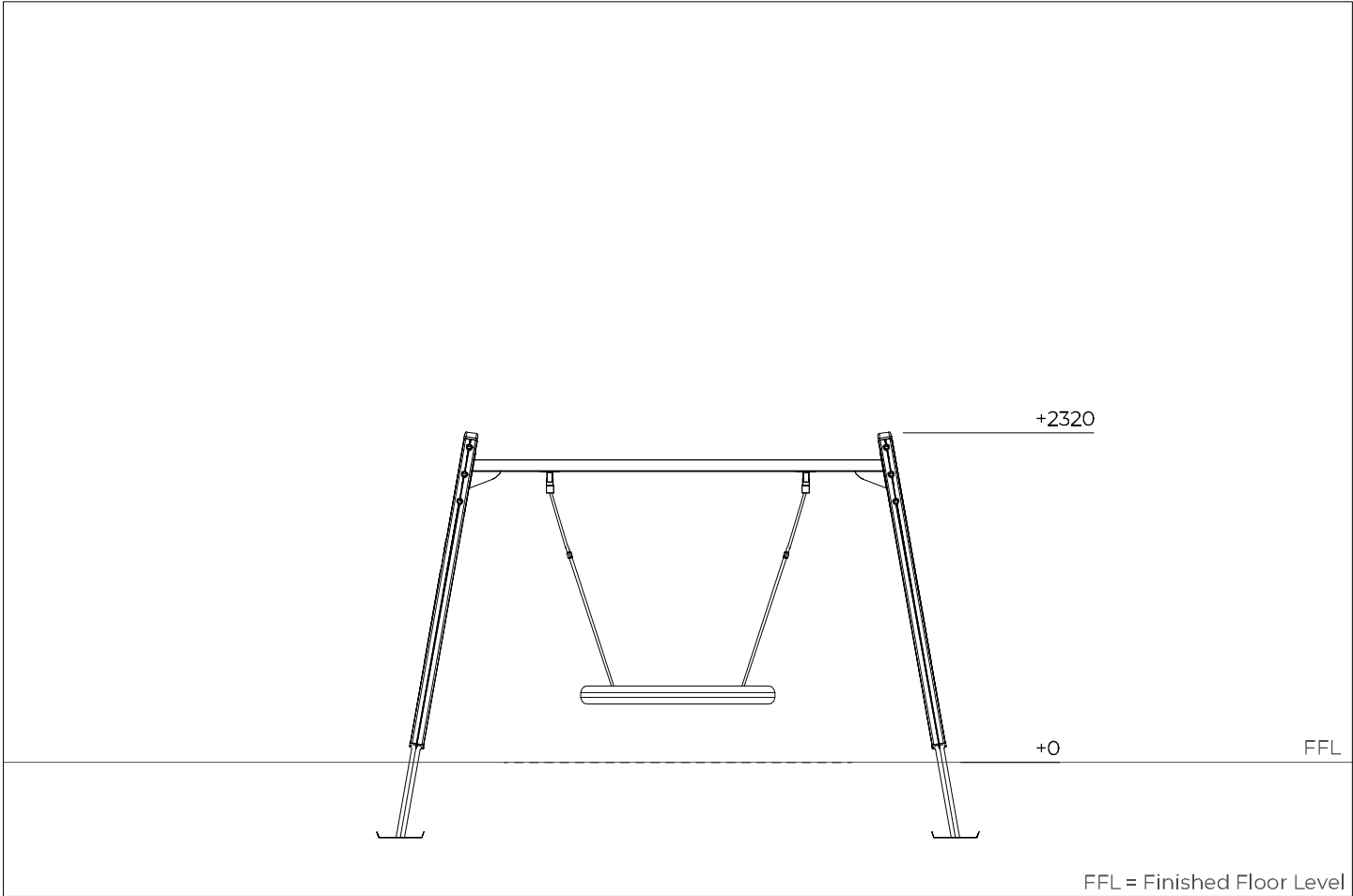

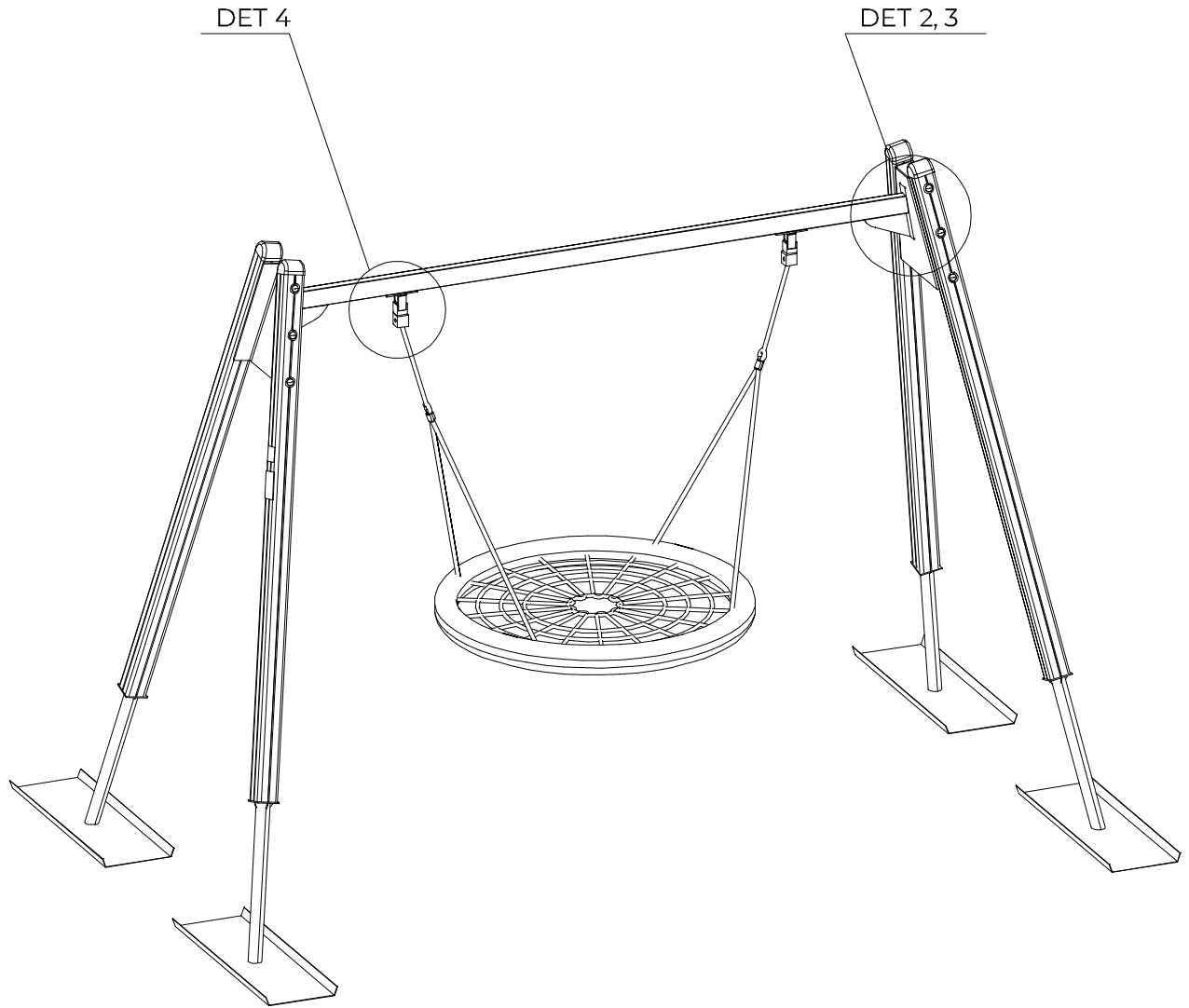

<p>DET 1</p>	<p>DET 2</p>	<p>DET 3</p>
<p>DET 4</p>		