

ASENNUSOHJE
MONTERINGSANSVISNING
INSTALLATION INSTRUCTION
AUFBAUANLEITUNG
NOTICE D'INSTALLATION

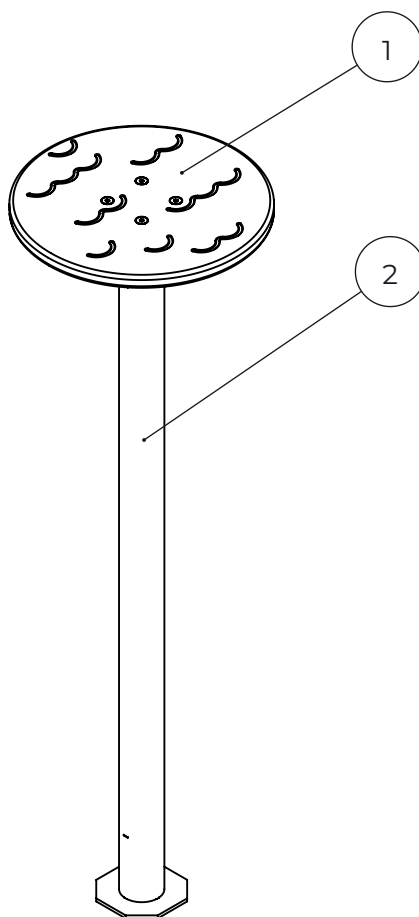

NO.	ITEM CODE			QTY.
1	712856-903	STEP ELEMENT		1
2	914967-413	FOOTING TUBE	115x115x1100	1

EN/AS Impact Area: 0m²
Falling Space: 9 m²
Max Falling Height: 550mm

