

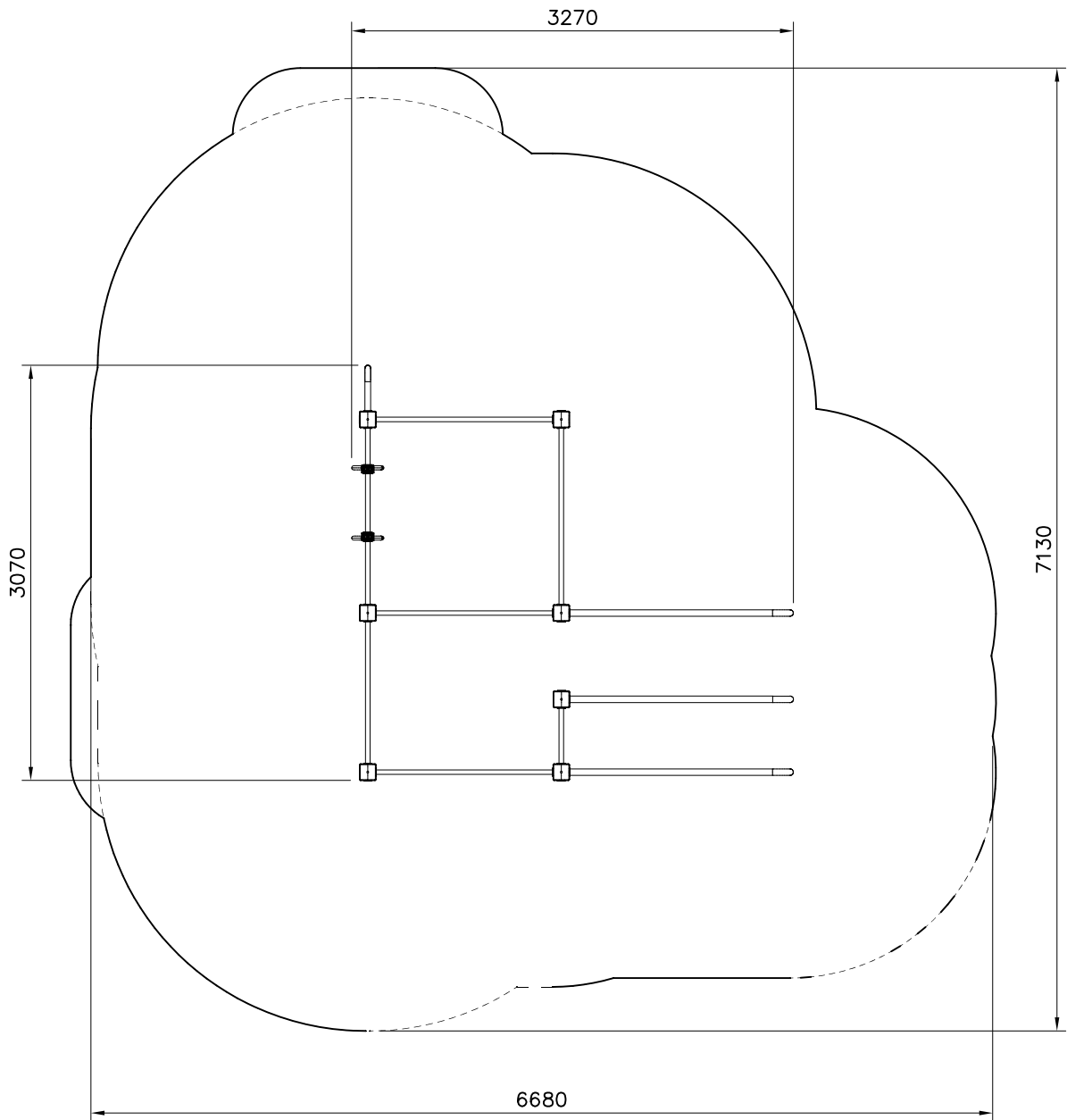

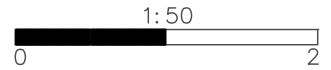

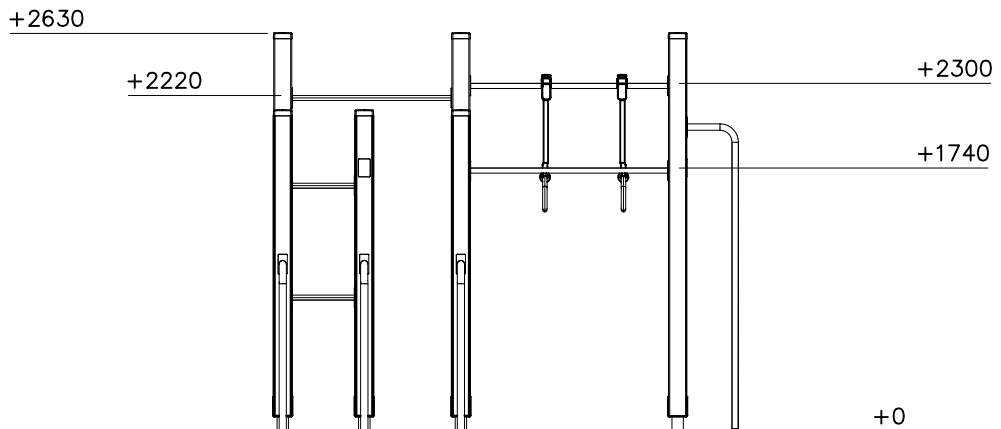

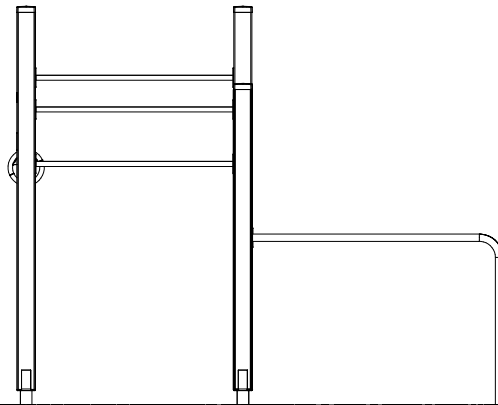

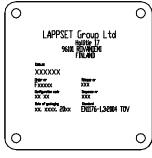

EN/AS Impact Area / Area of movement 36 m<sup>2</sup>

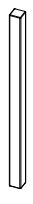
Max Falling Height 2300 mm

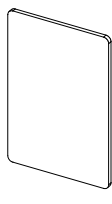
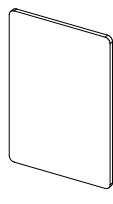
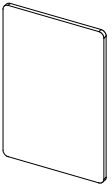
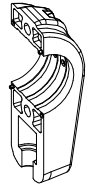
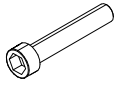

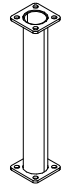
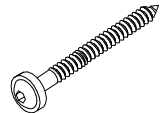
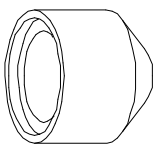
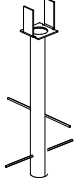

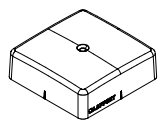
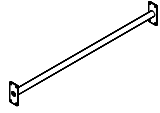
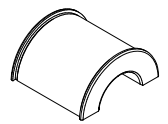
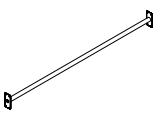
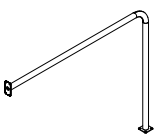
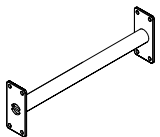
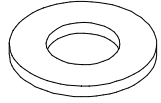
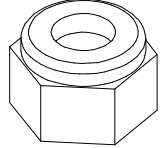
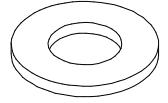
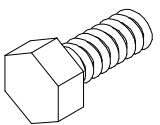
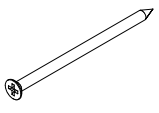
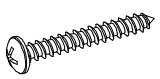
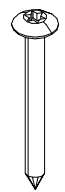
DATE: 5.10.2022

702286  65x65	PCS 1	705040  Ø16x764	PCS 2	705322  118x118x2500	PCS 4	705347  118x118x1990	PCS 3	707881  118x78	PCS 1	707882  118x78	PCS 1
707883  118x78	PCS 1	902195  150x50x50	PCS 4	902232  M10x55	PCS 2	902233  M10x30	PCS 2	902272  90x90x450	PCS 3	903093  Ø8x90	PCS 12
905104  M10	PCS 28	905761  120x120x700	PCS 7	905817-216  2626x386x60	PCS 1	905830  123x123x40	PCS 7	905838-216  L 1060	PCS 1	906006  Ø64/36,4x59	PCS 4
908017-216  L 1315	PCS 5	908019-216  1500x1200	PCS 3	908062-216  L 420	PCS 2	909256  Ø16/8.4	PCS 80	909637  M10	PCS 12	909638  Ø20/10.5	PCS 24
909639  M10x25	PCS 12	980104  Ø5x90	PCS 7	980114  Ø4x20	PCS 16	980123  Ø7x60	PCS 96	980161  M10	PCS 4		PCS
	PCS		PCS		PCS		PCS		PCS		PCS
	PCS		PCS		PCS		PCS		PCS		PCS