











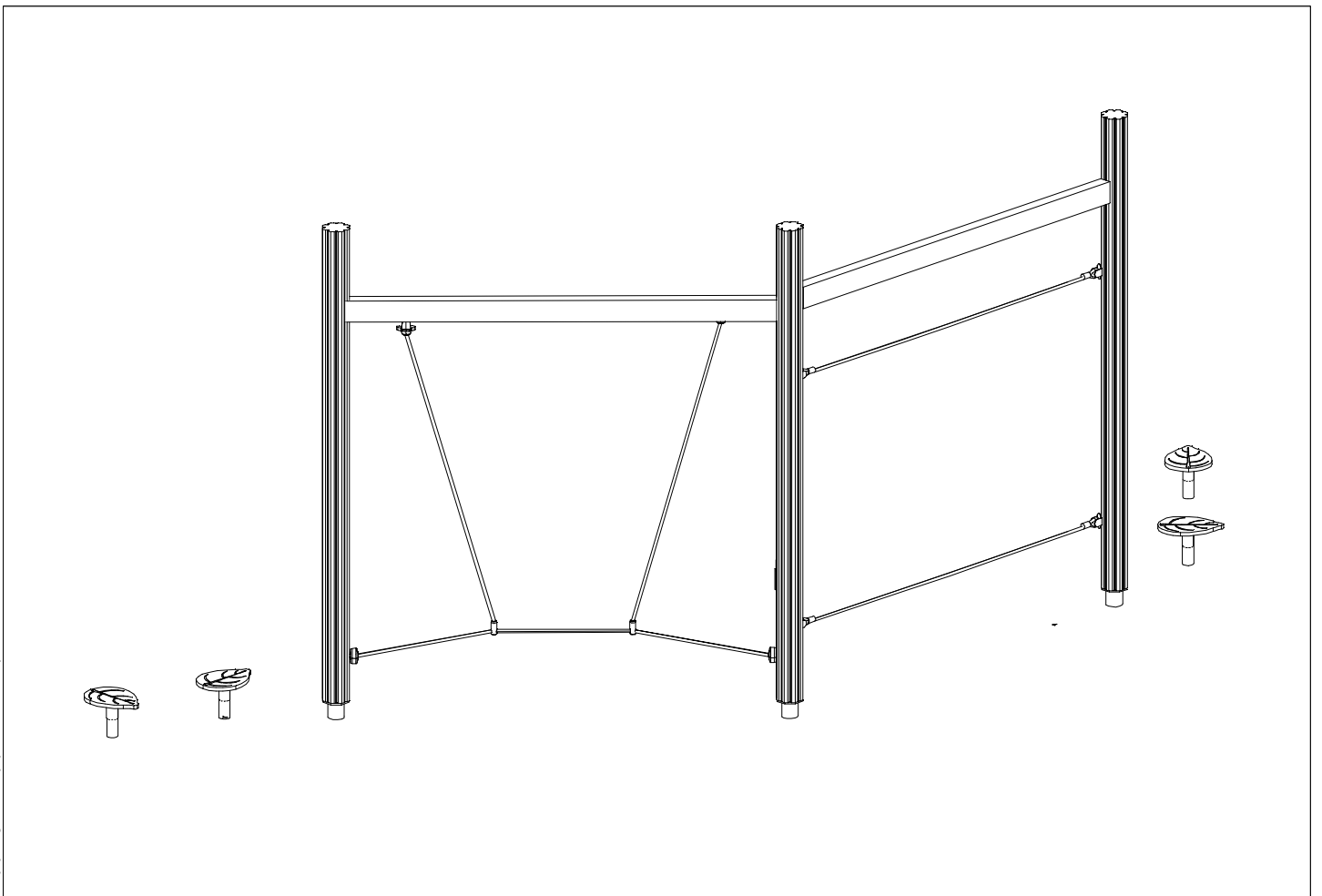



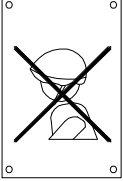
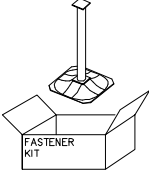
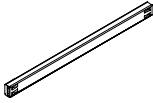

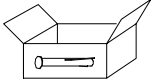
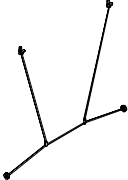
FLORA

ASENNUSOHJE MONTERINGSANSVISNING INSTALLATION INSTRUCTION AUFBAUANLEITUNG NOTICE D'INSTALLATION

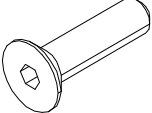
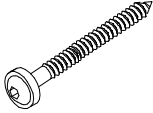
DATE: 5.2.2026

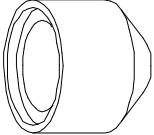
Q19616

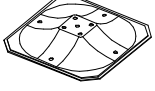
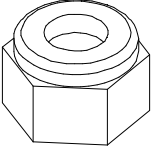
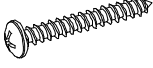

<p>702286</p>  <p>65x65</p>	PCS 1	<p>702339</p>  <p>118x78</p>	PCS 1	<p>706531</p> 	PCS 4	<p>707294</p>  <p>70x120x2304</p>	PCS 2	<p>707822</p>  <p>140x140x2650</p>	PCS 3	<p>707866</p> 	PCS 3
<p>711515</p>  	PCS 1	<p>711863</p>  	PCS 2	<p>901487</p>  <p>M10x40</p>	PCS 16	<p>903093</p>  <p>Ø8x90</p>	PCS 8	<p>903112</p>  <p>135x135x750</p>	PCS 3	<p>905104</p>  <p>M10</p>	PCS 16
<p>909511</p>  <p>L=650</p>	PCS 4	<p>909519</p>  <p>50x380x380</p>	PCS 4	<p>909637</p>  <p>Ø20/10,5</p>	PCS 16	<p>980114</p>  <p>Ø4x20</p>	PCS 8	<p>P03805</p>  <p>20x307x292</p>	PCS 4		PCS
	PCS		PCS		PCS		PCS		PCS		PCS
	PCS		PCS		PCS		PCS		PCS		PCS
	PCS		PCS		PCS		PCS		PCS		PCS
	PCS		PCS		PCS		PCS		PCS		PCS

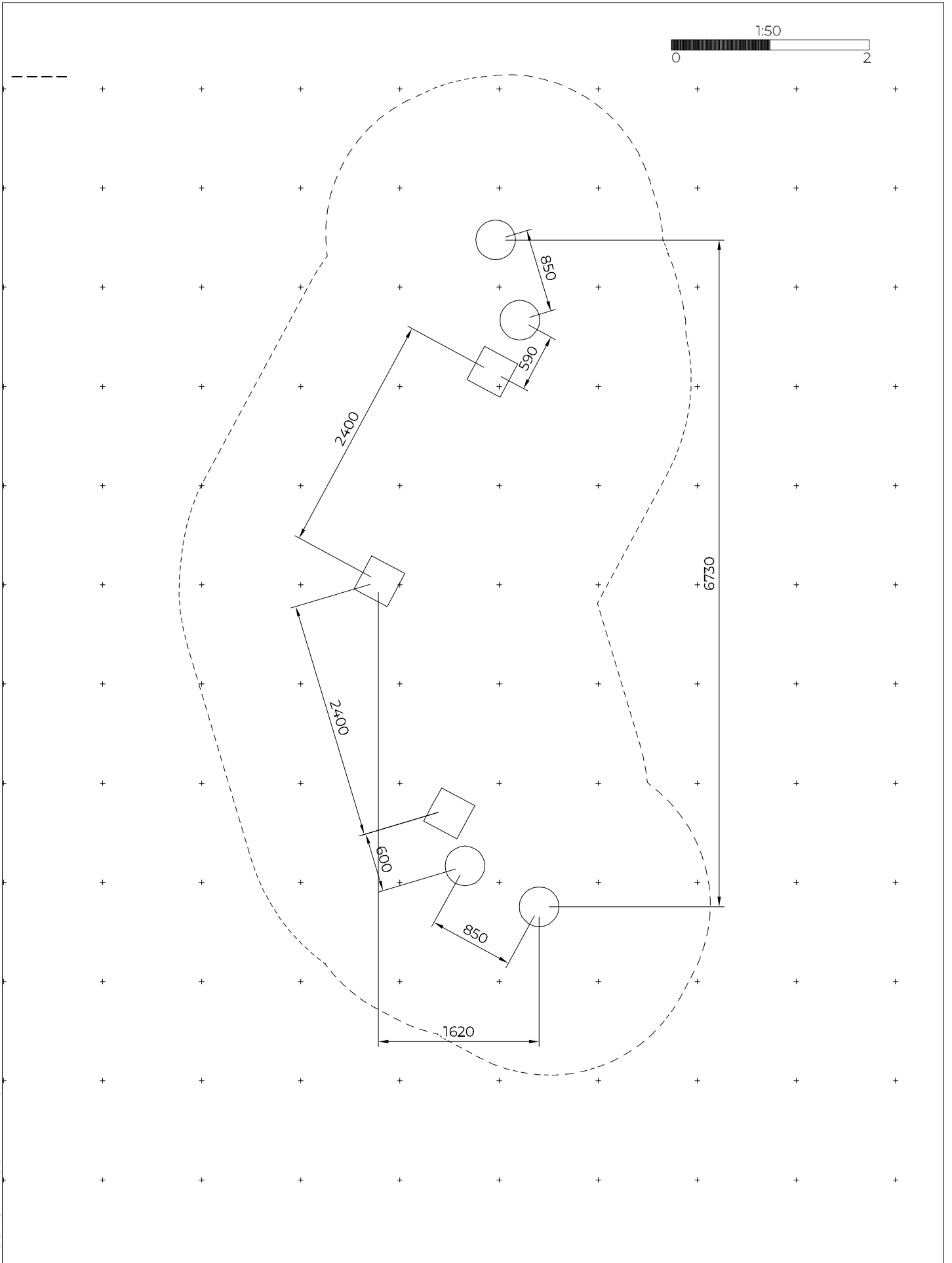

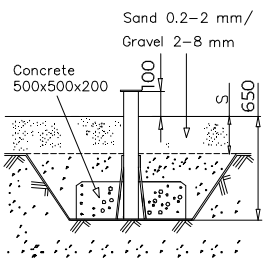
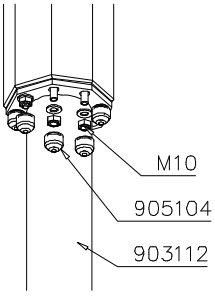
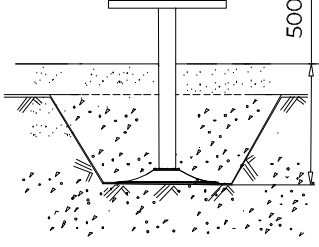
<p>□</p> 	<p>□</p> 	<p>○</p> 

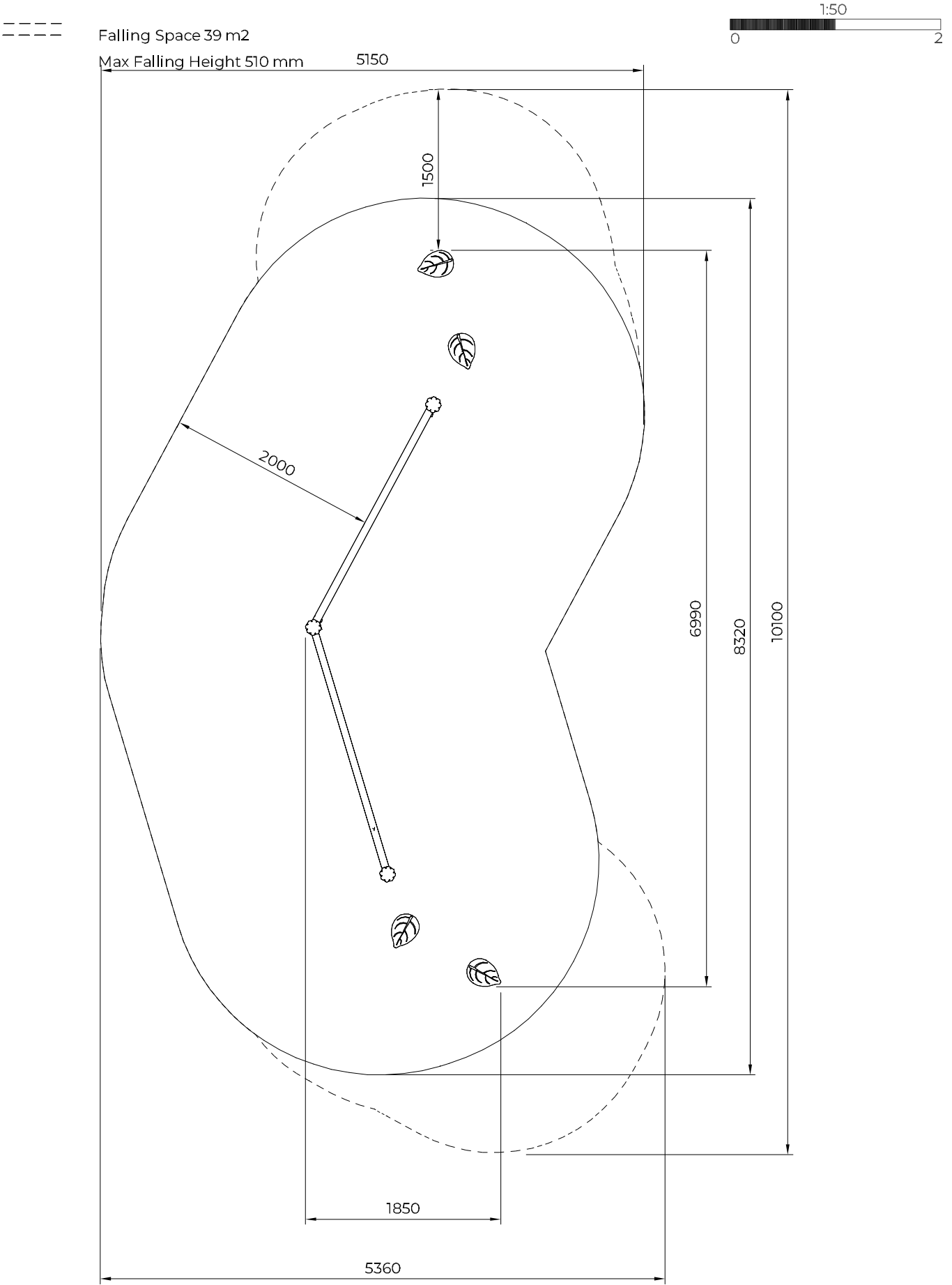

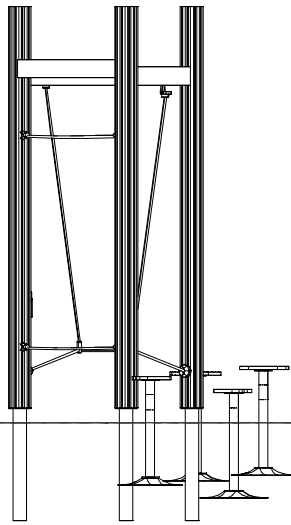

FFL

FFL = Finished Floor Level

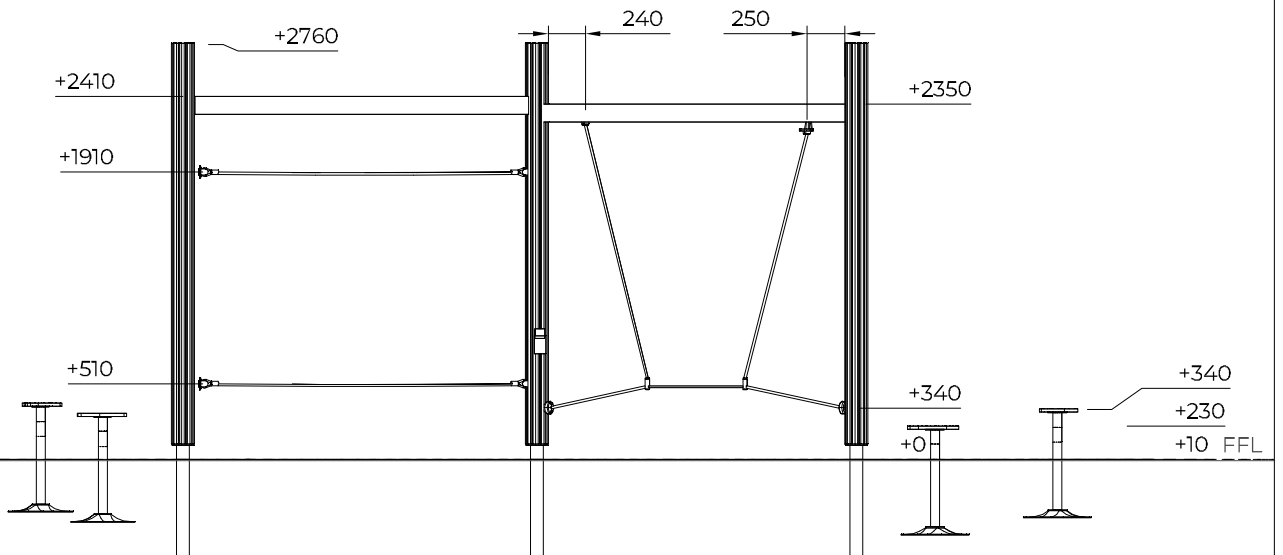

FFL = Finished Floor Level

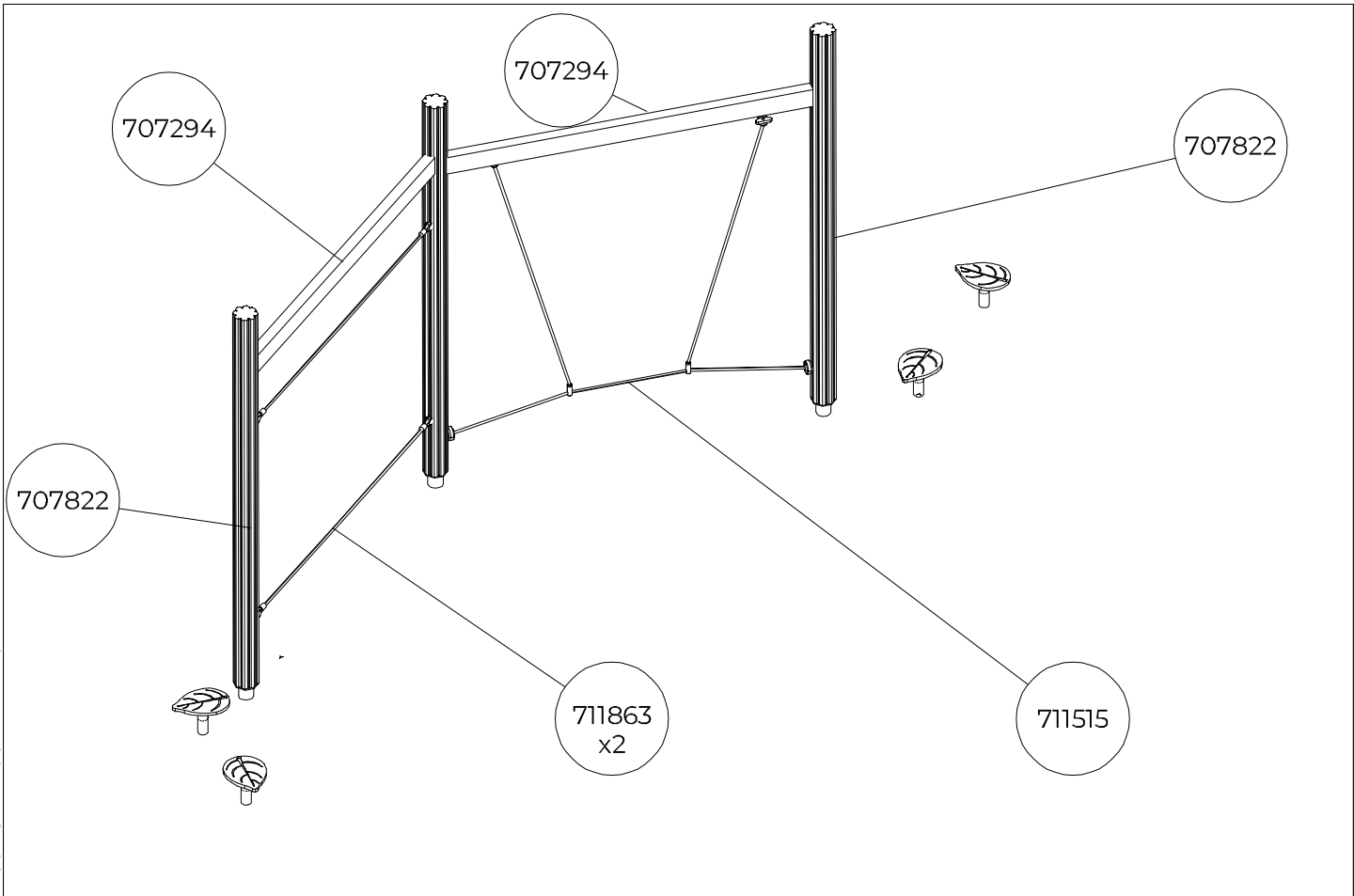
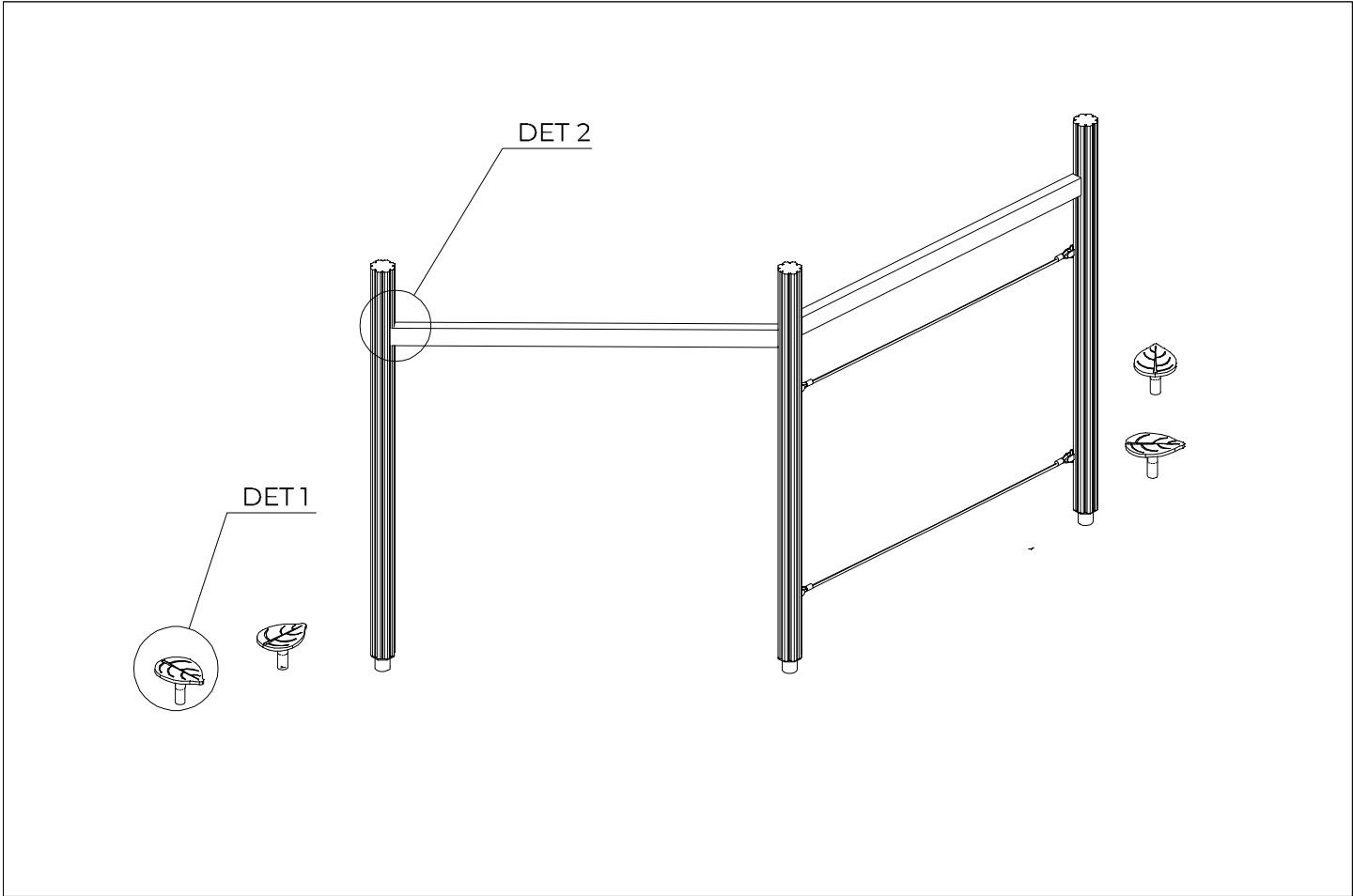

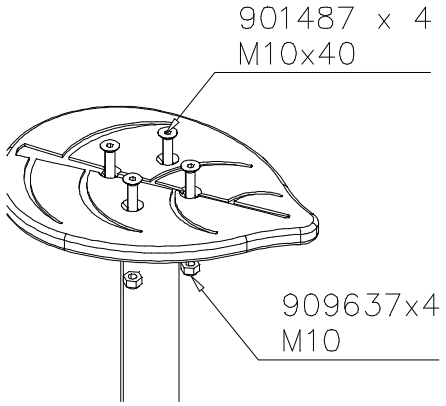
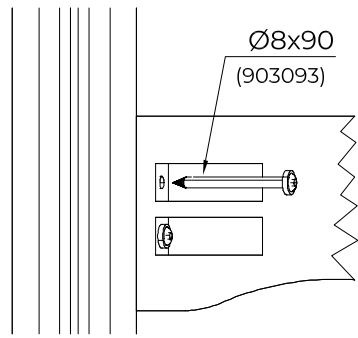
<p>DET 1</p>  <p>901487 x 4 M10x40</p> <p>909637x4 M10</p>	<p>DET 2</p>  <p>Ø8x90 (903093)</p>	

