

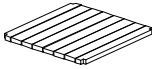

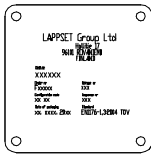

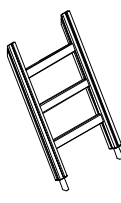

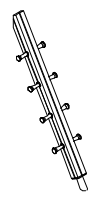

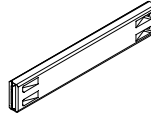
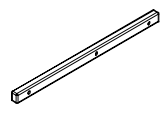
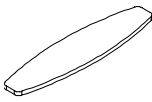
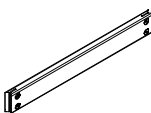
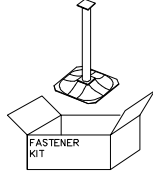
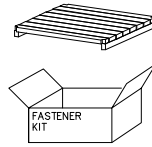
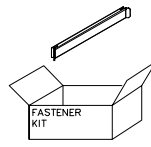
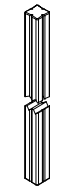
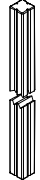

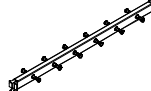

008986	PCS 4	702286	PCS 1	703130	PCS 1	703133	PCS 1	706439	PCS 49	706443	PCS 8
											
750x750		65x65						L 704		32x45x702	
706453	PCS 5	706510	PCS 3	706531	PCS 24	706535	PCS 4	706538	PCS 3	706568	PCS 12
											
15x145x600		45x120x1030								93x93x3000	
706669	PCS 4	706810	PCS 8	707262	PCS 1	707288-305	PCS 2	707290	PCS 1	707315	PCS 8
											
93x93x2400		93x93x2650				L 2305		127x300x2355			
707696-704	PCS 7	707729	PCS 7	707732	PCS 4	902086	PCS 7	903093	PCS 204	905112	PCS 4
											
15x265x275						148x172x254		Ø8x90		Ø22	
905138	PCS 24	905196	PCS 24	907688-216	PCS 4	909256	PCS 12	909511	PCS 24	909519	PCS 24
											
GRAY		GRAY				Ø16/8.4		90x90x650		50x380x380	
980114	PCS 4	980123	PCS 20	980128	PCS 20	980131	PCS 96				
											
Ø4x20		Ø7x60		Ø7x40		Ø6x60					
	PCS		PCS		PCS		PCS		PCS		PCS

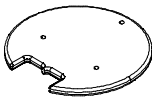
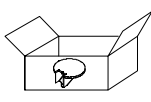
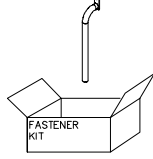
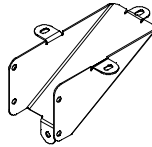
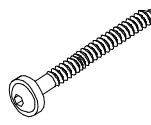
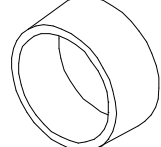
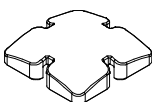
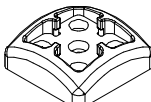
- EN/AS Impact Area 57 m²
- - - - Falling Space 59 m²
- Max Falling Height 1980 mm

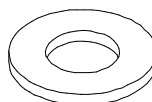

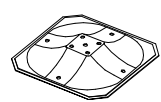
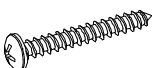

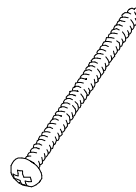
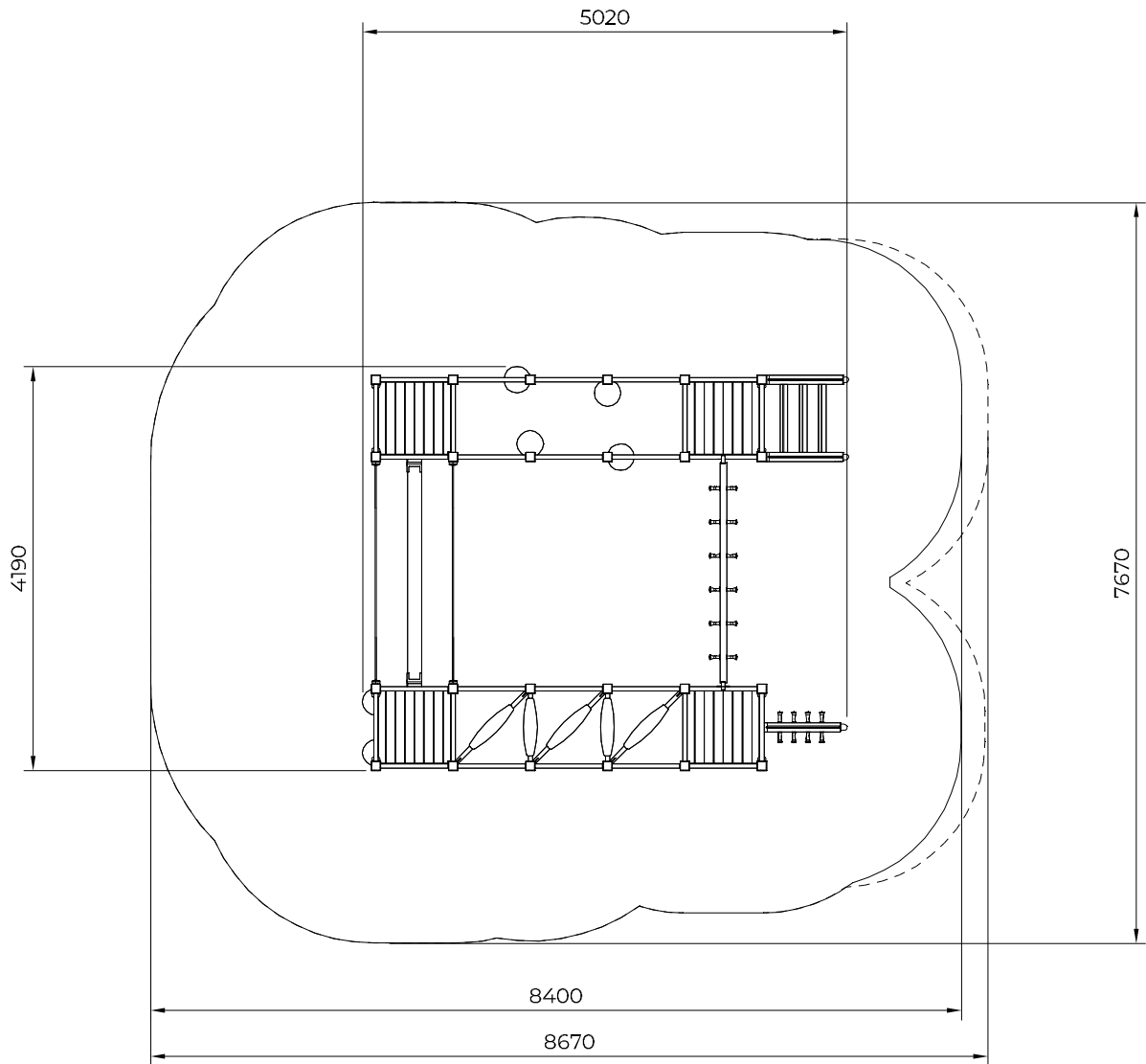
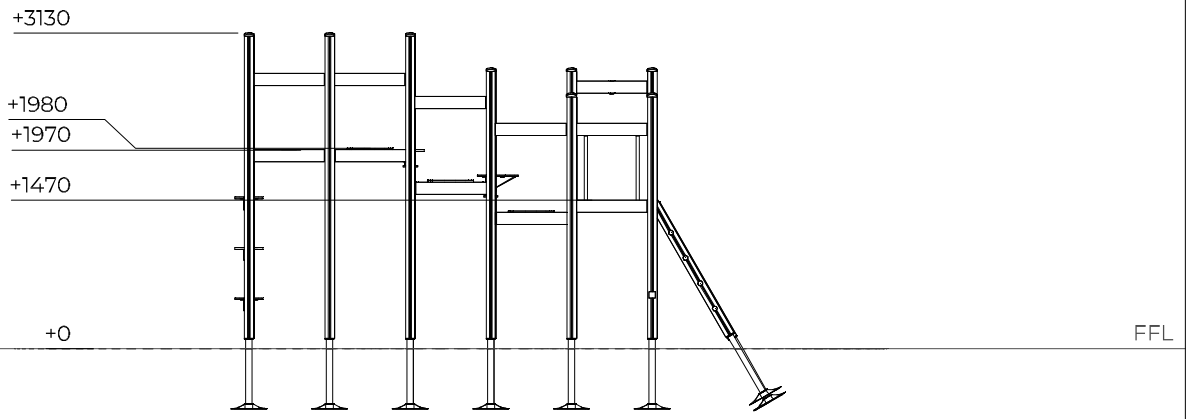
FFL = Finished Floor Level

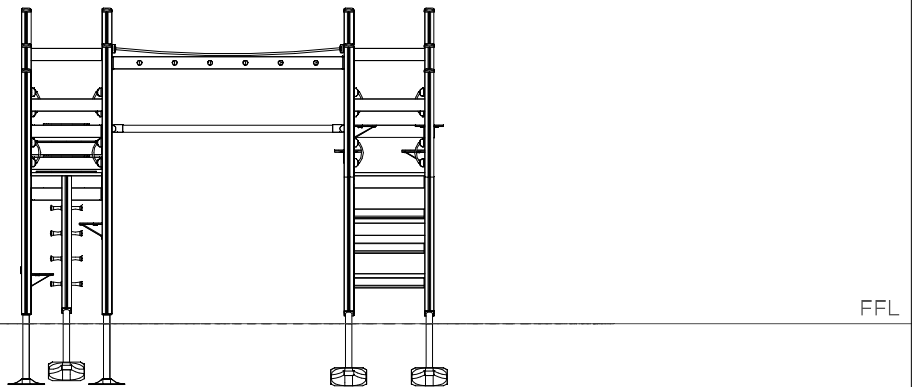

FFL = Finished Floor Level

