







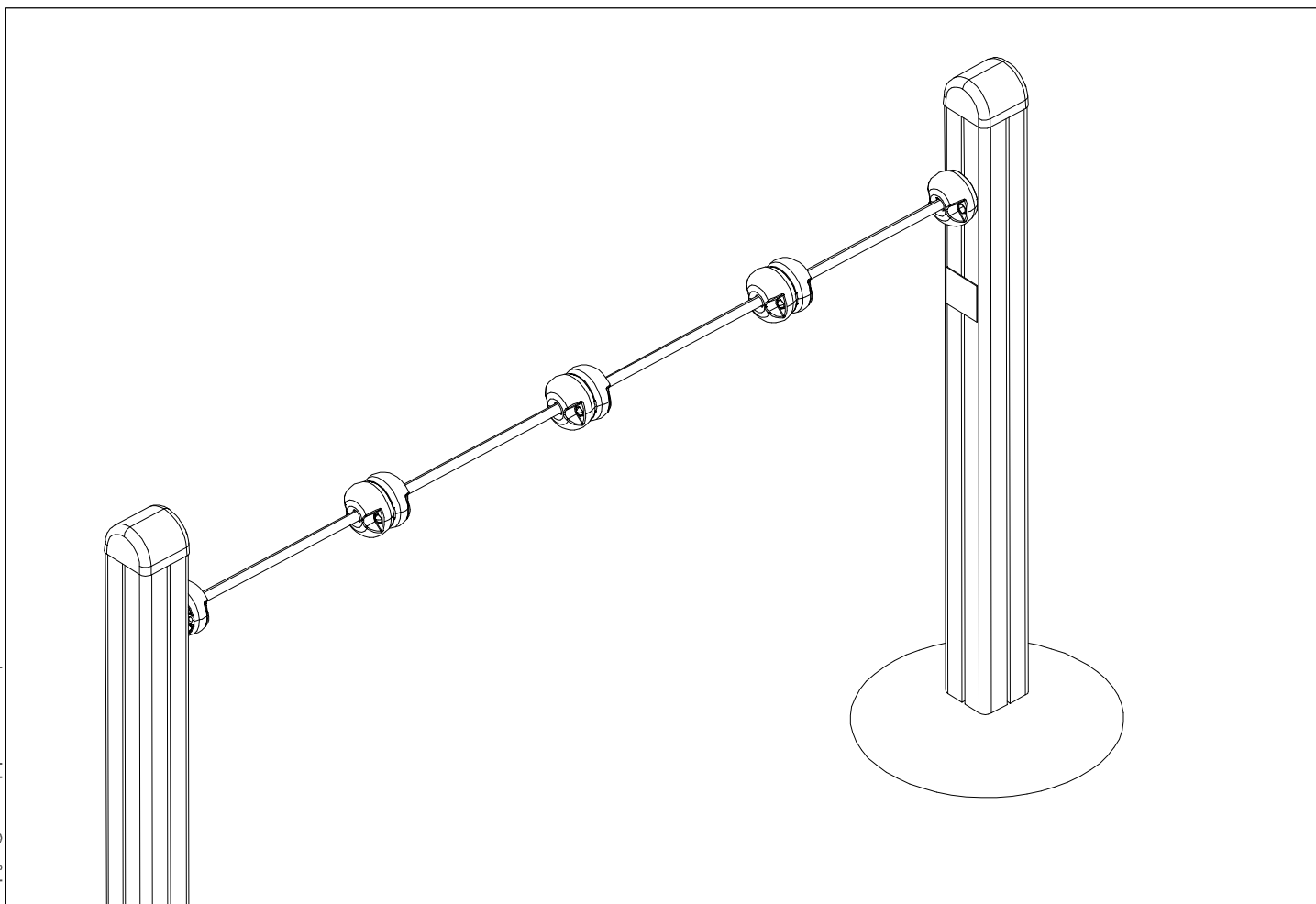

PRIME

ASENNUSOHJE
MONTERINGSANSVISNING
INSTALLATION INSTRUCTION
AUFBAUANLEITUNG
NOTICE D'INSTALLATION

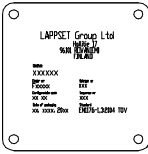
DATE: 13.4.2026

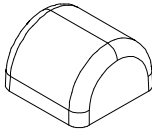
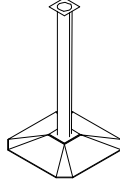
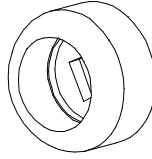
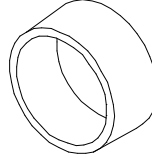
QF1029

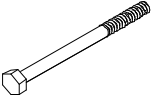
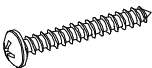
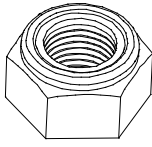
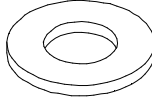

702286	PCS	712026-001	PCS	712788	PCS	712889	PCS	905083	PCS	905112	PCS
	1		2		2		2		4		2
65x65		L 1050				L 700 		Ø32		Ø22	
906503	PCS	980114	PCS	980150	PCS	980151	PCS	P18306-303	PCS		PCS
	4		4		4		4		1		
8x120		Ø4x20		M8		Ø16/8.4		1500			
	PCS		PCS		PCS		PCS		PCS		PCS
	PCS		PCS		PCS		PCS		PCS		PCS
	PCS		PCS		PCS		PCS		PCS		PCS
	PCS		PCS		PCS		PCS		PCS		PCS

----- Falling Space 18 m2

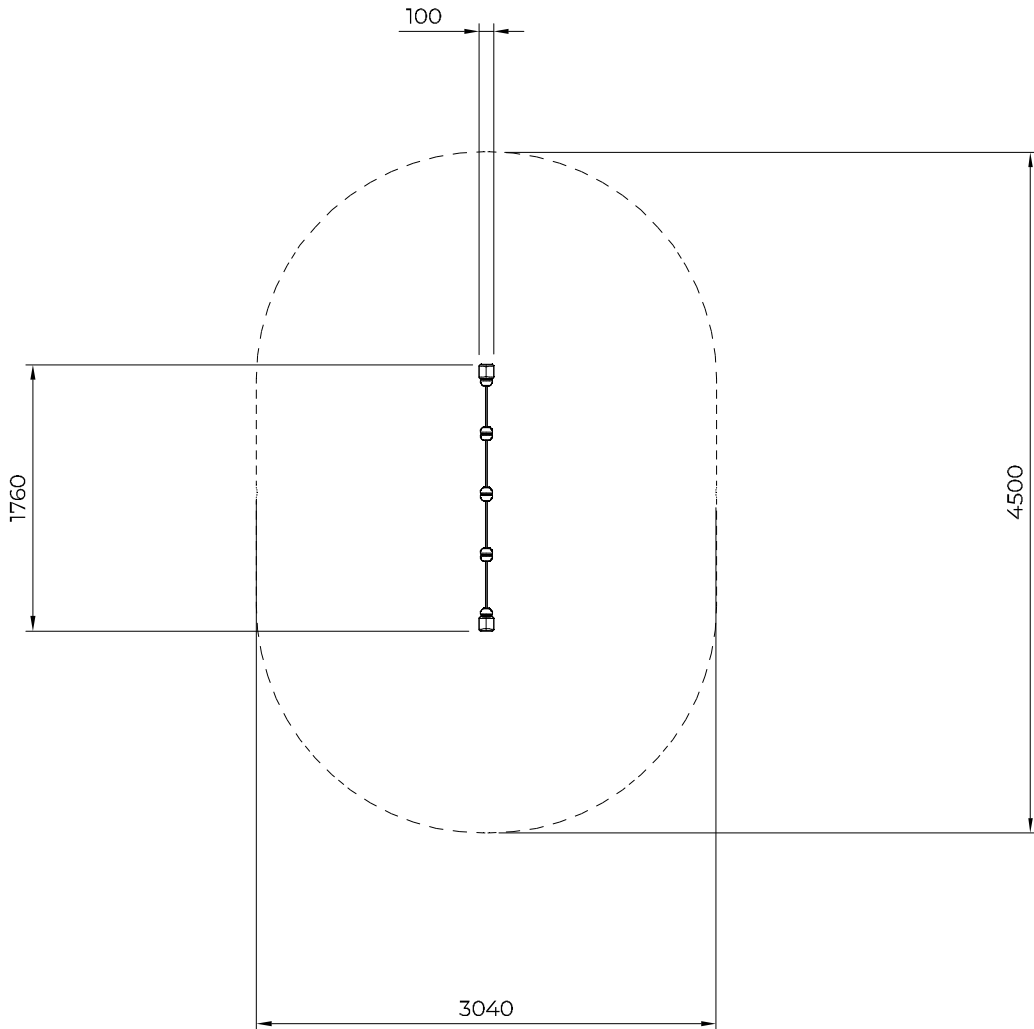
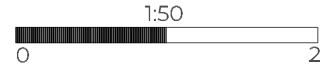

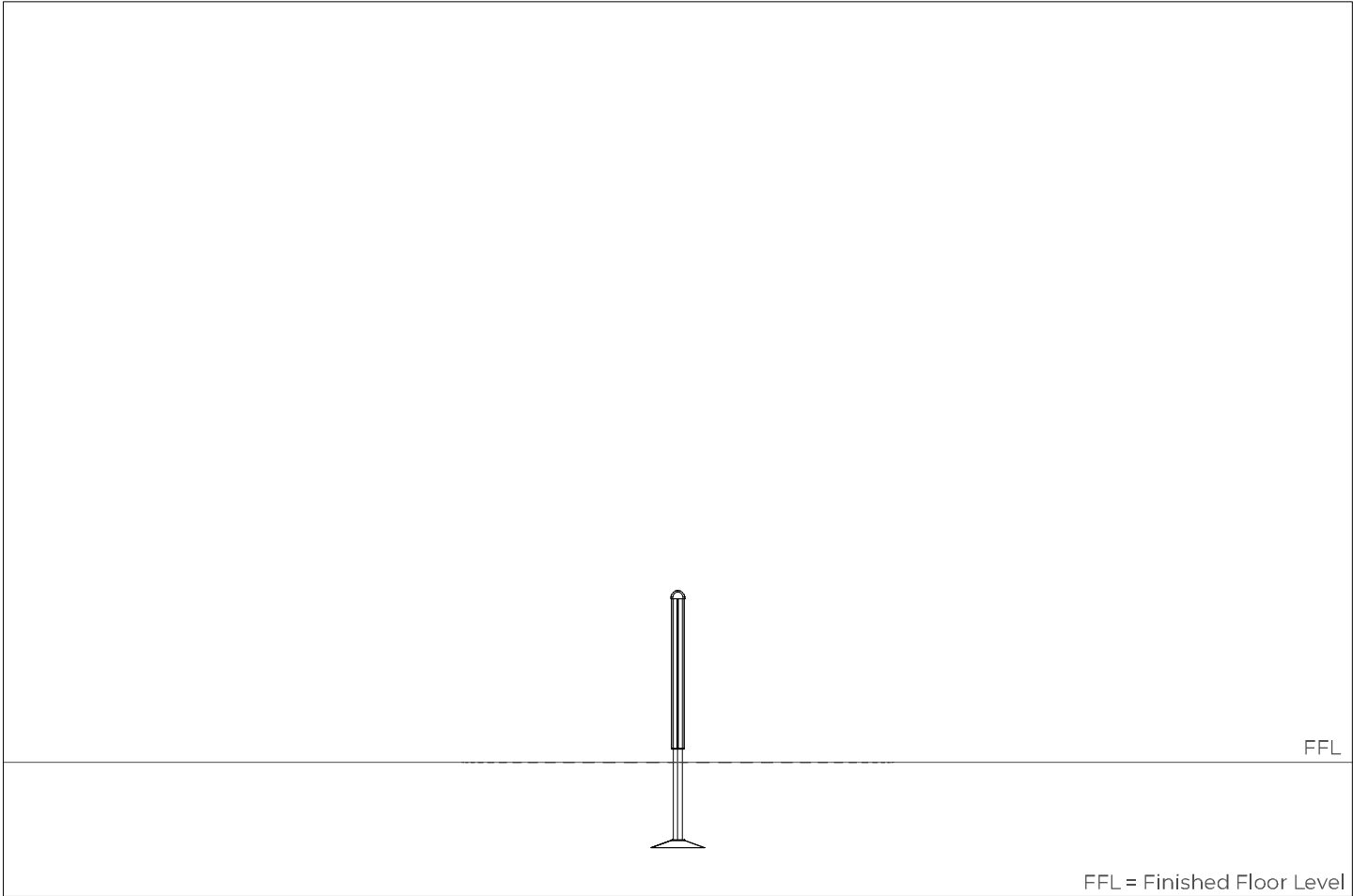

FFL = Finished Floor Level

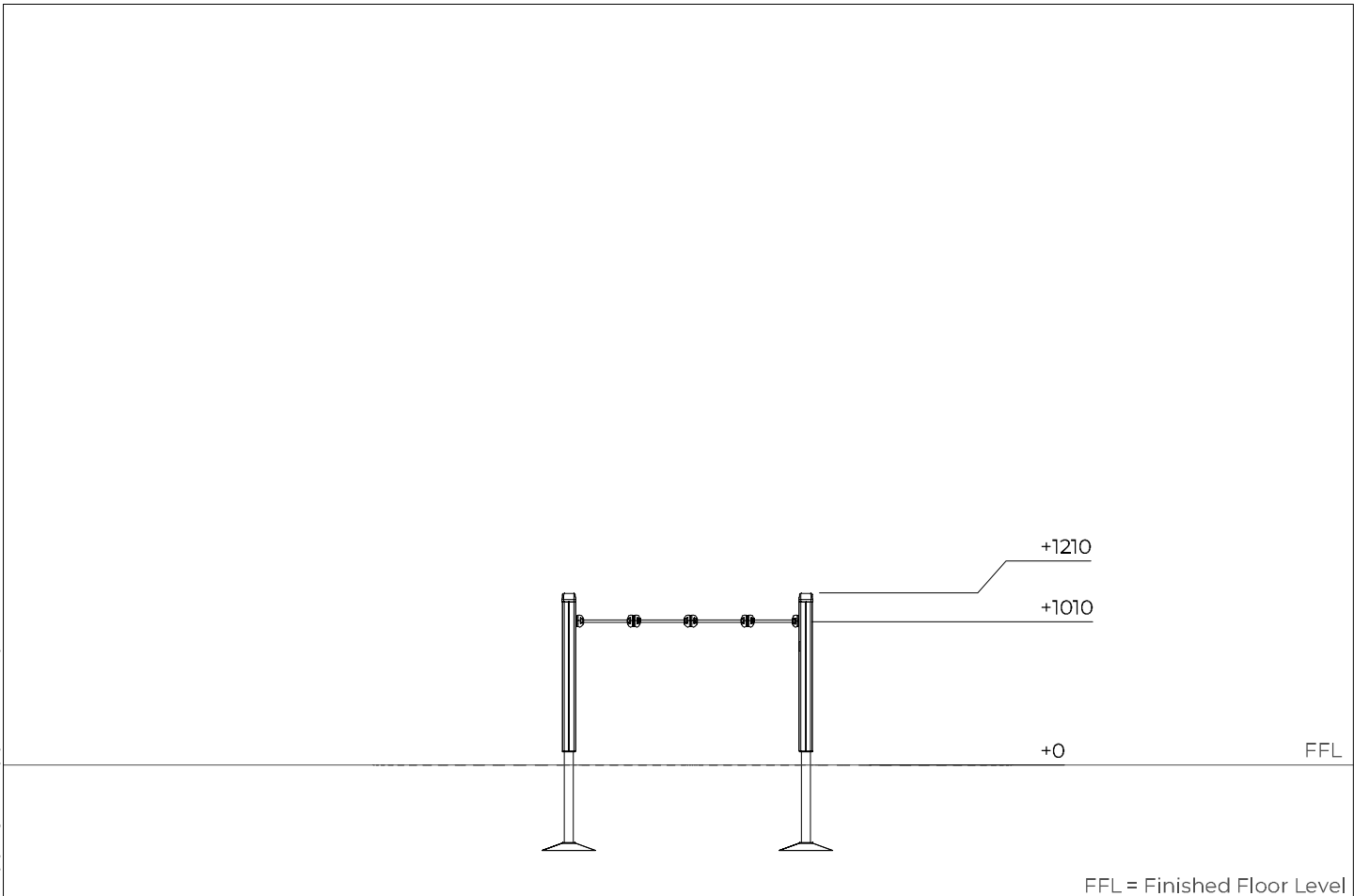

FFL = Finished Floor Level

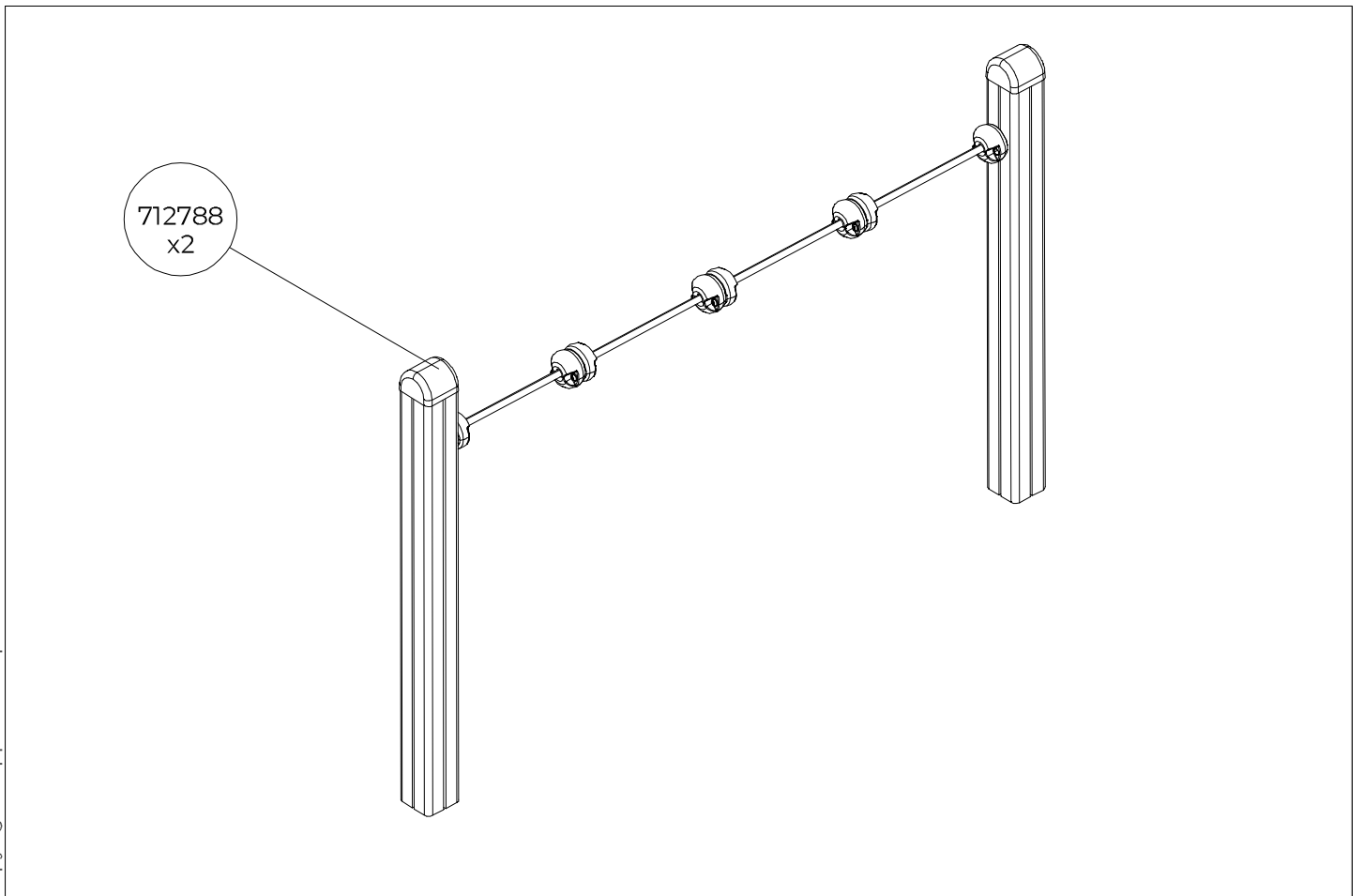
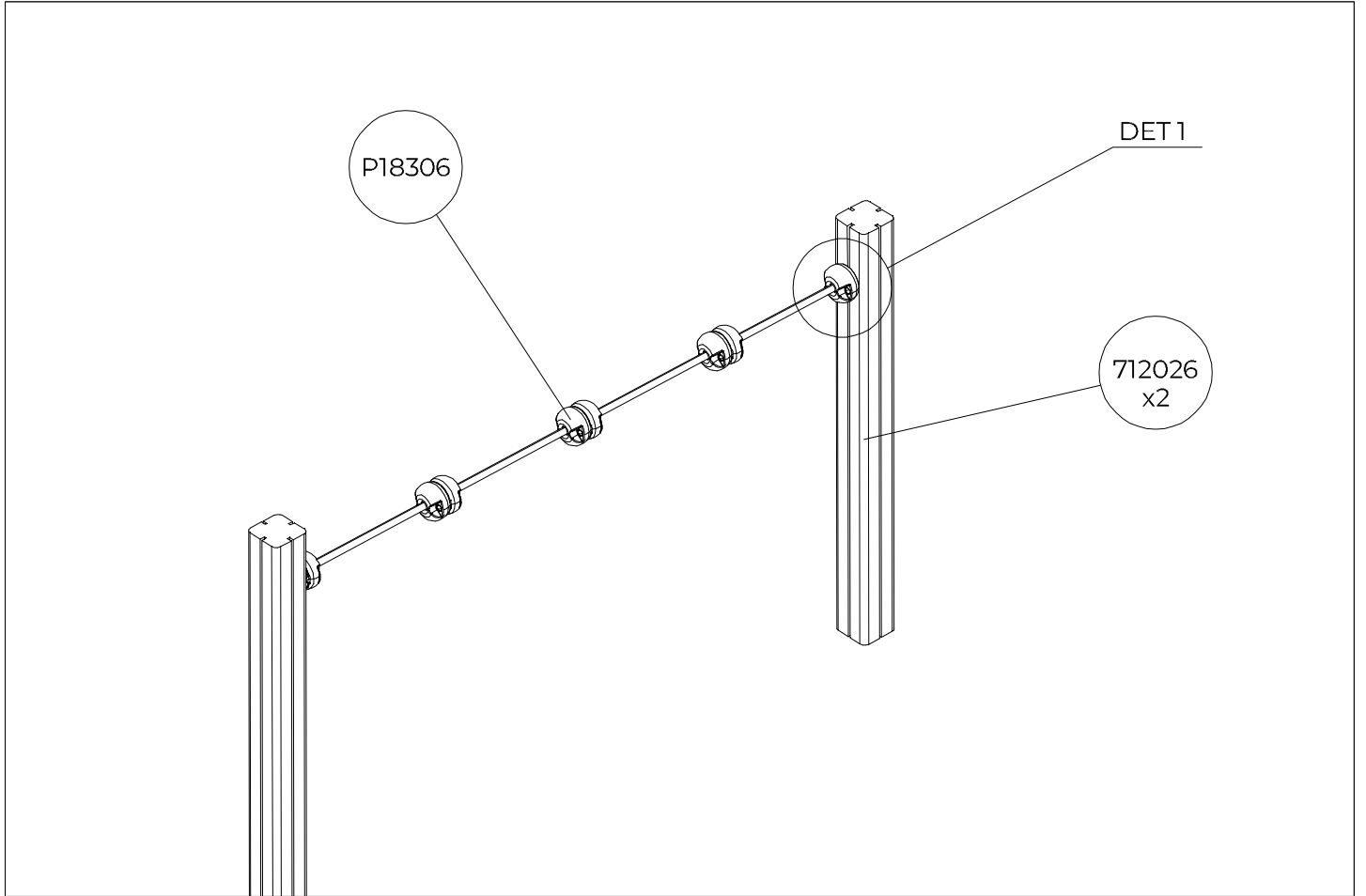

DET 1

