













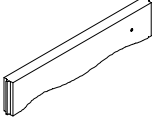

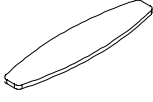
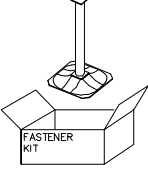
FLORA

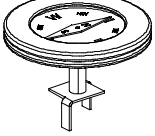
ASENNUSOHJE  
MONTERINGSANSVISNING  
INSTALLATION INSTRUCTION  
AUFBAUANLEITUNG  
NOTICE D'INSTALLATION

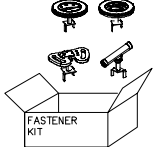
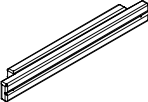
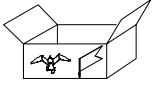
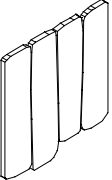
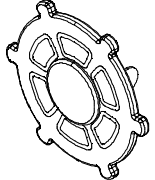
DATE: 20.4.2026

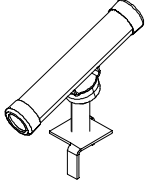
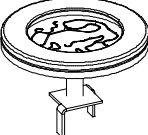
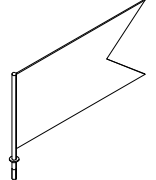
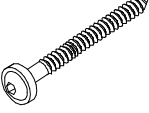
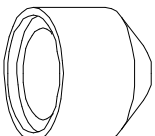
QFL0247-1

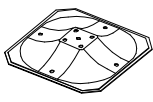
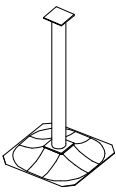
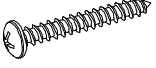
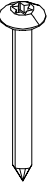
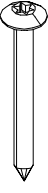
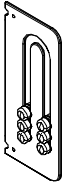
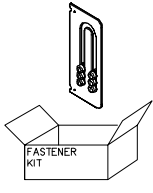
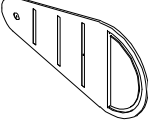

702286  65x65	PCS 1	705211-001  45x145x715	PCS 6	706192-001  93x93x946	PCS 7	706453-707  15x145x600	PCS 2	706531  FASTENER KIT	PCS 4	706664  93x93x2540	PCS 1
706894  L 950	PCS 1	707303-707  FASTENER KIT	PCS 1	707331  93x93x470	PCS 2	707585  FASTENER KIT	PCS 1	707626  L 890	PCS 1	707693 	PCS 1
711519-001  FASTENER KIT	PCS 6	711524  FASTENER KIT	PCS 1	711534-001  FASTENER KIT	PCS 8	711535  FASTENER KIT	PCS 1	711580  FASTENER KIT	PCS 1	900793-206 	PCS 1
903093  Ø8x90	PCS 26	905104  M10	PCS 28	909511  90x90x650	PCS 4	909519  50x380x380	PCS 4	909521  FASTENER KIT	PCS 7	980114  Ø4x20	PCS 4
980123  Ø7x60	PCS 8	980128  Ø7x40	PCS 16	P13979-707  10x250x600	PCS 1	P13981  FASTENER KIT	PCS 1	P18568 	PCS 2	P20507  Regt door Zes	PCS 2
	PCS		PCS		PCS		PCS		PCS		PCS
	PCS		PCS		PCS		PCS		PCS		PCS

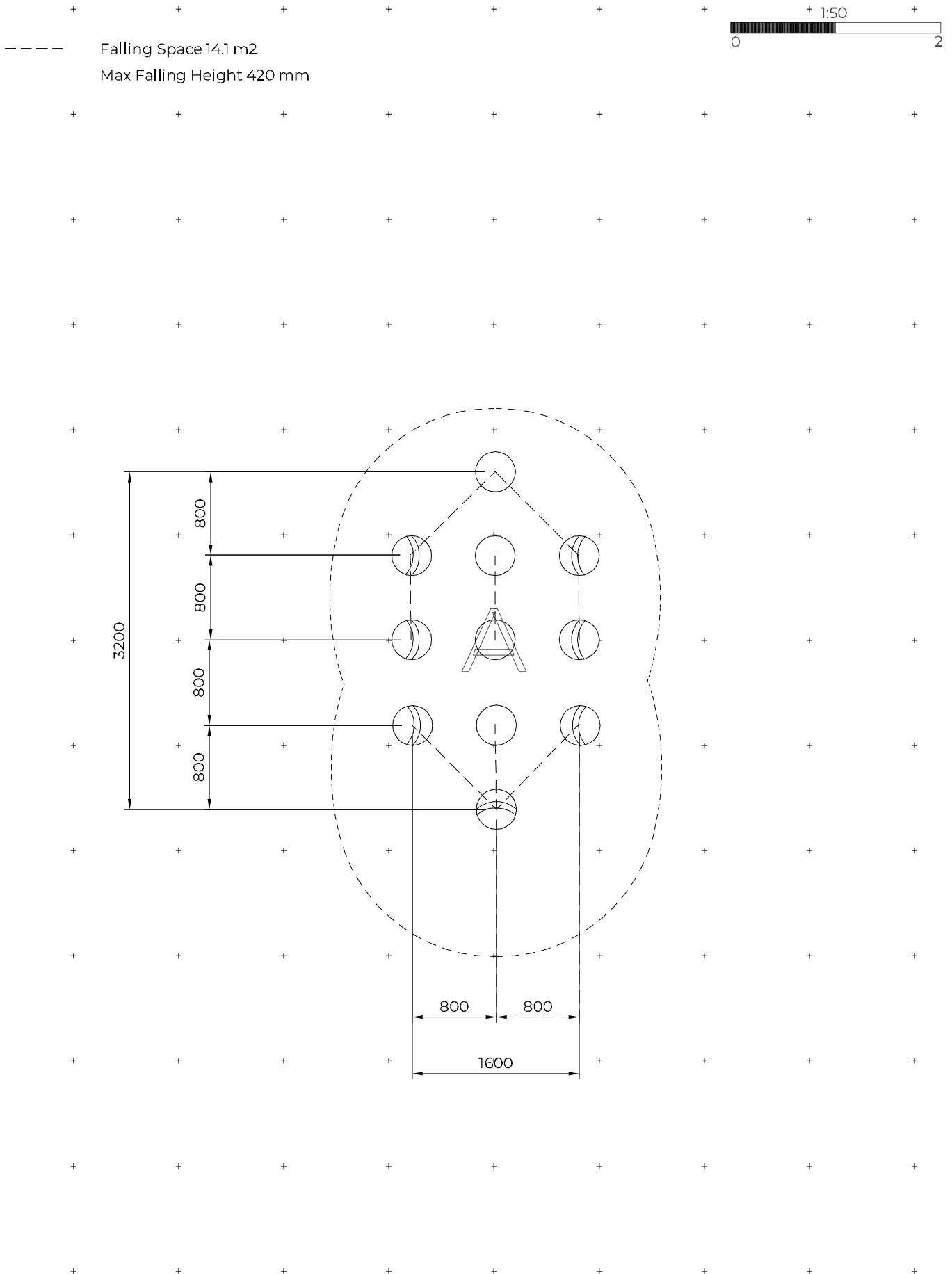

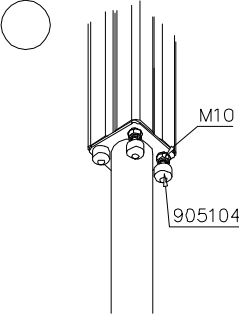
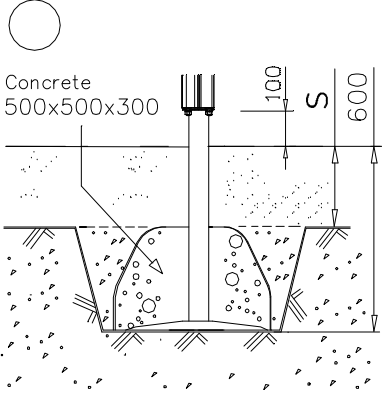

----- Falling Space 14.1 m<sup>2</sup>  
Max Falling Height 420 mm

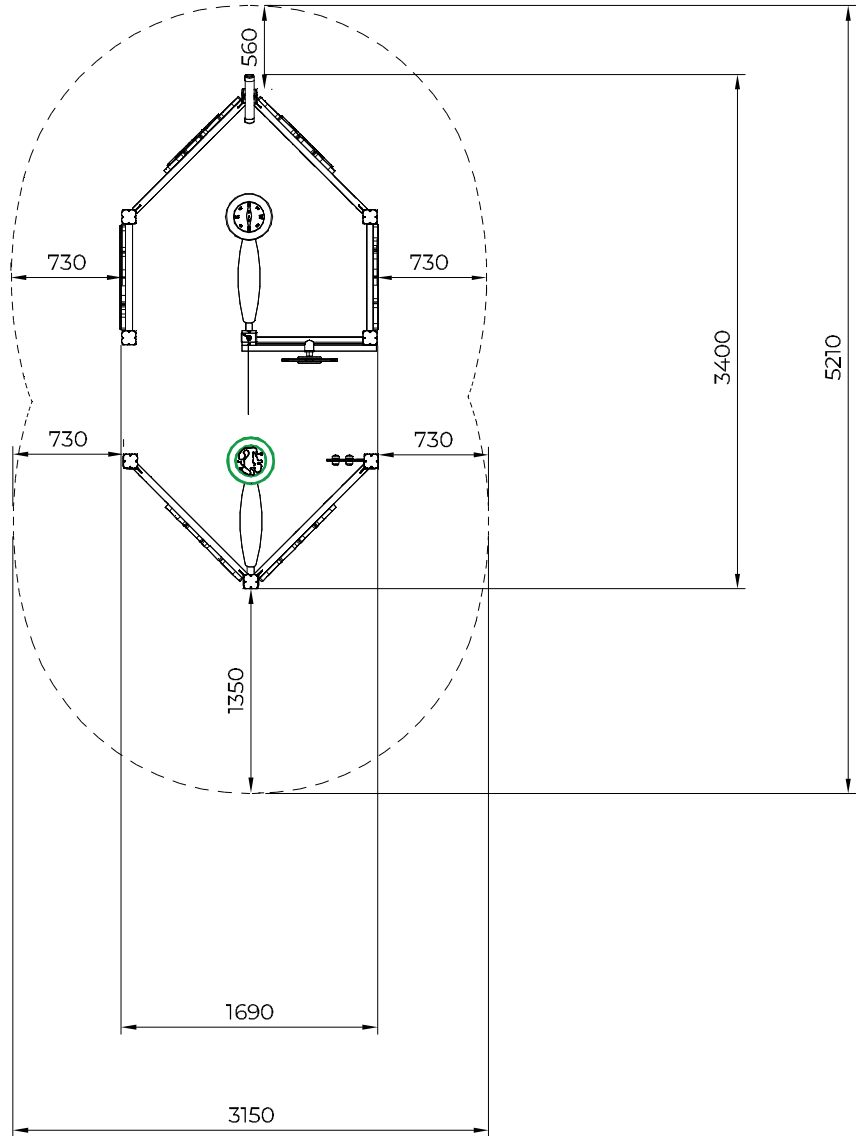
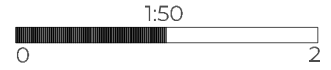

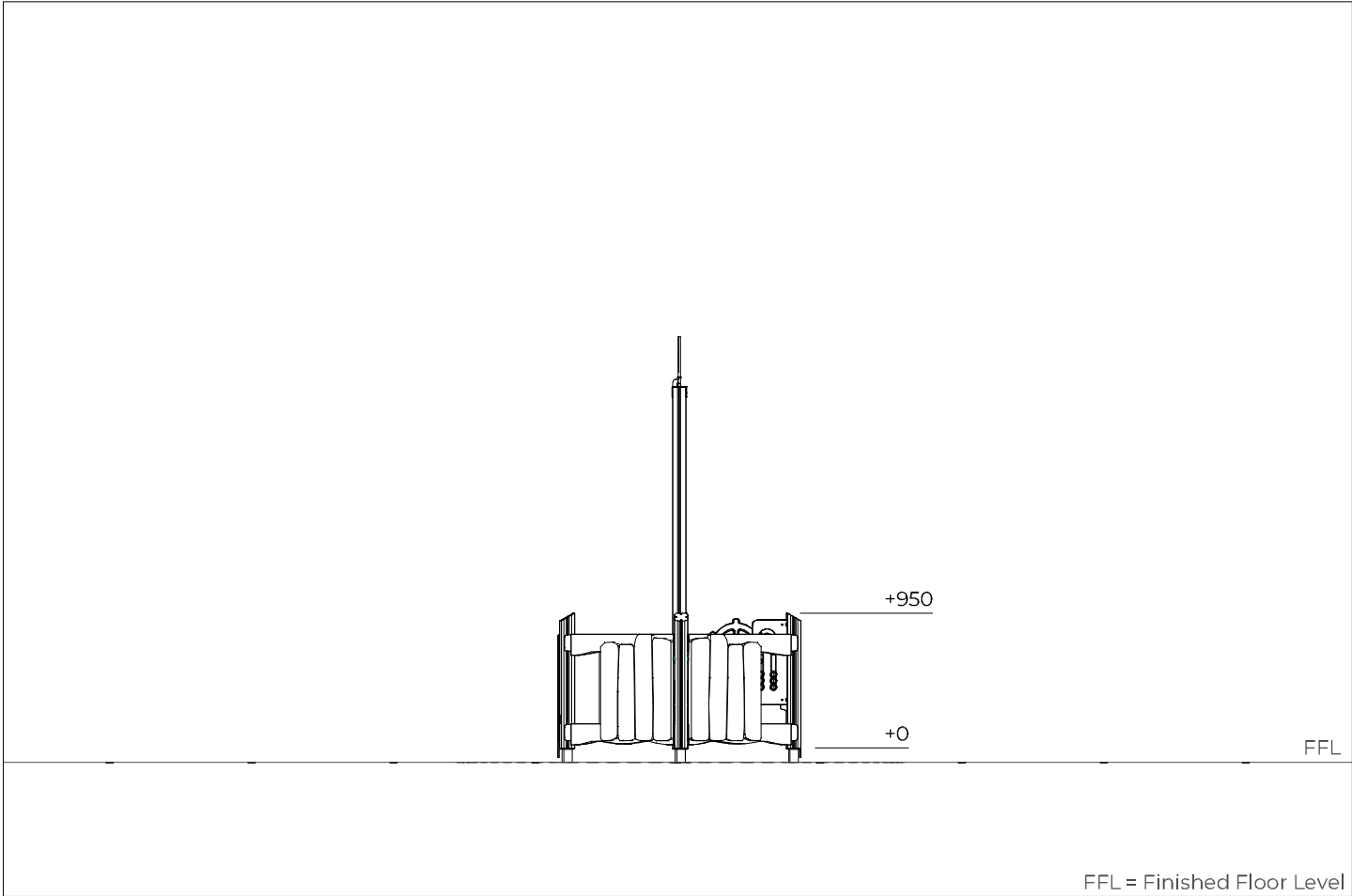

FFL = Finished Floor Level

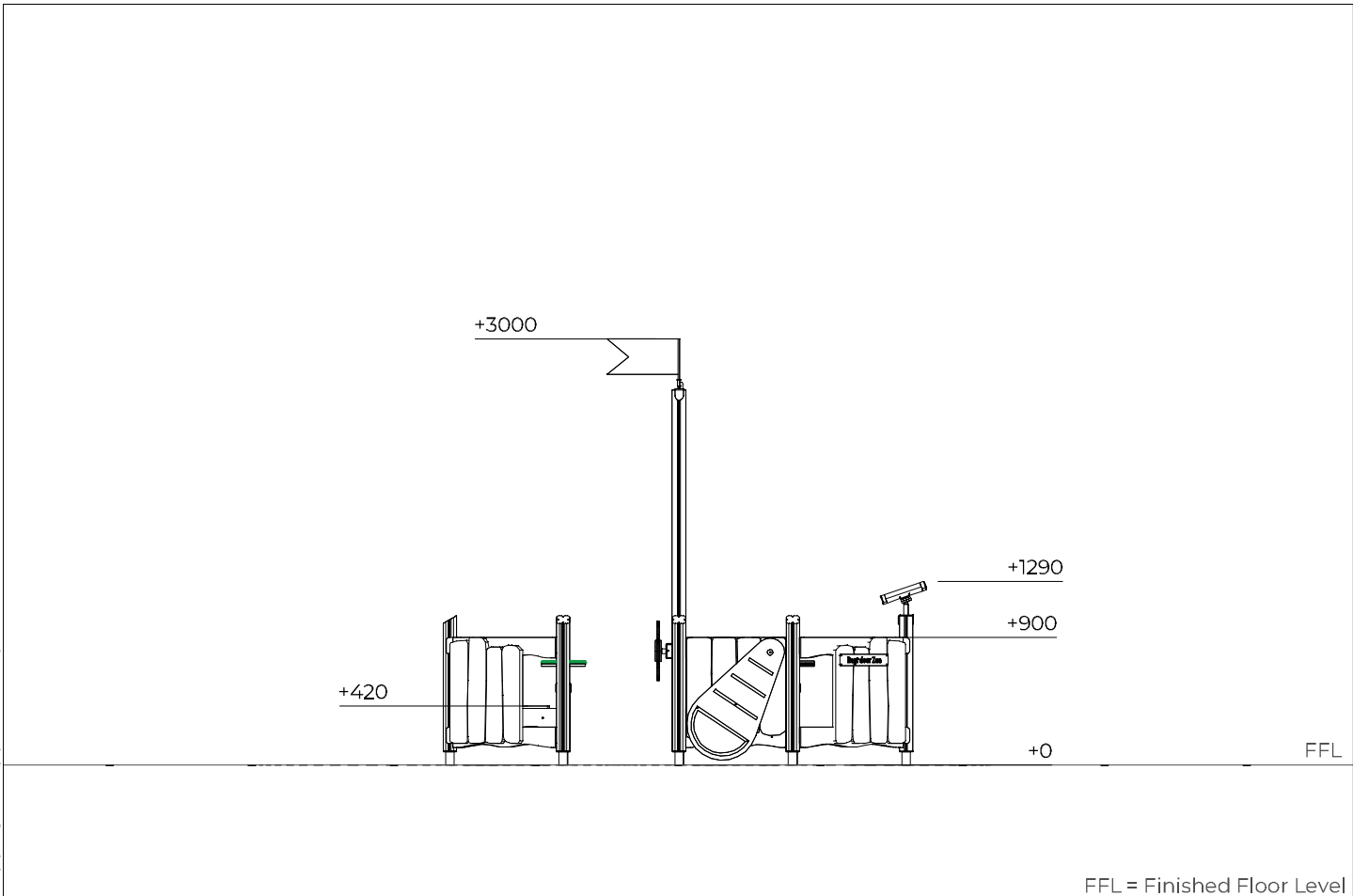

FFL = Finished Floor Level

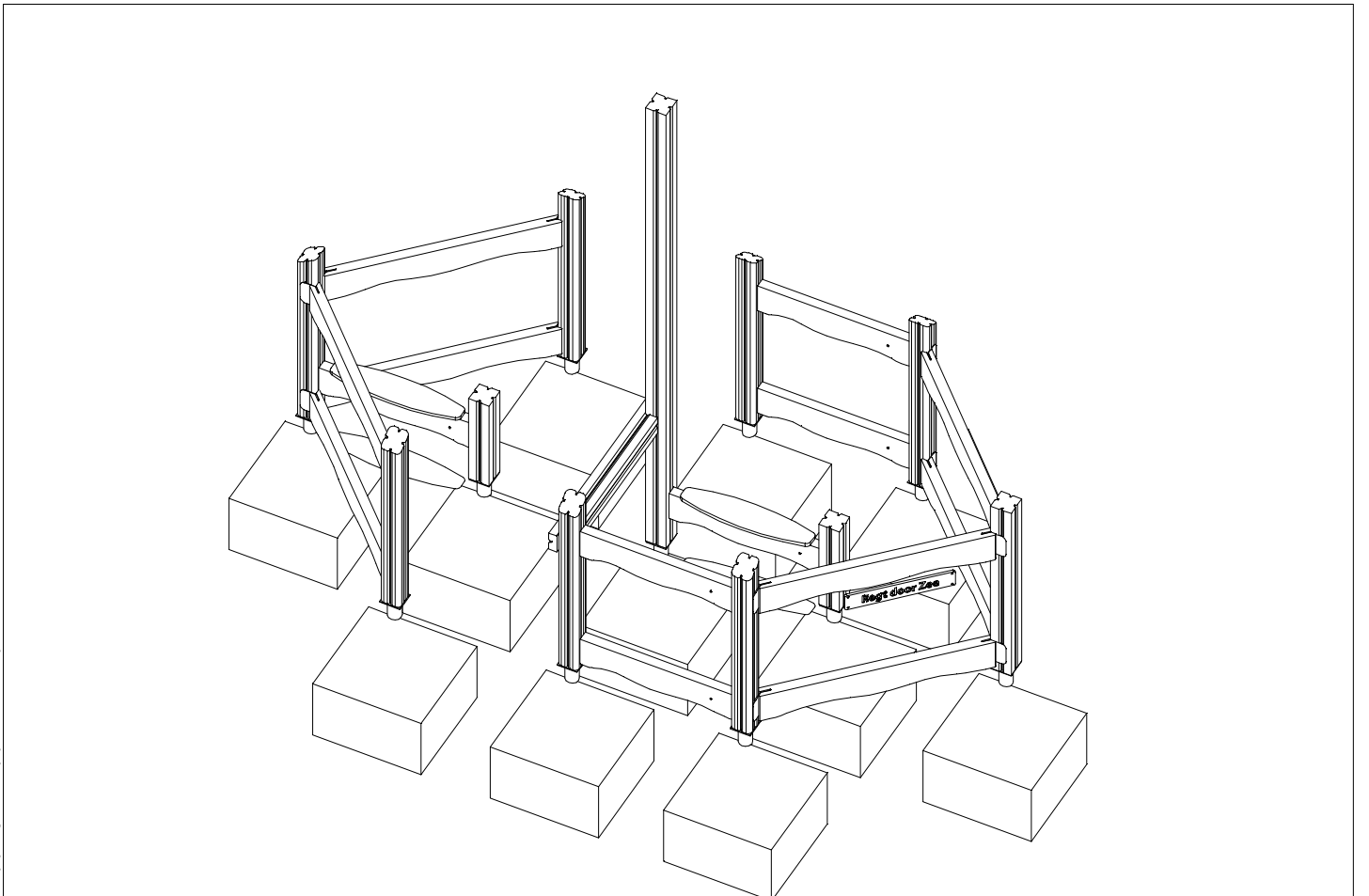
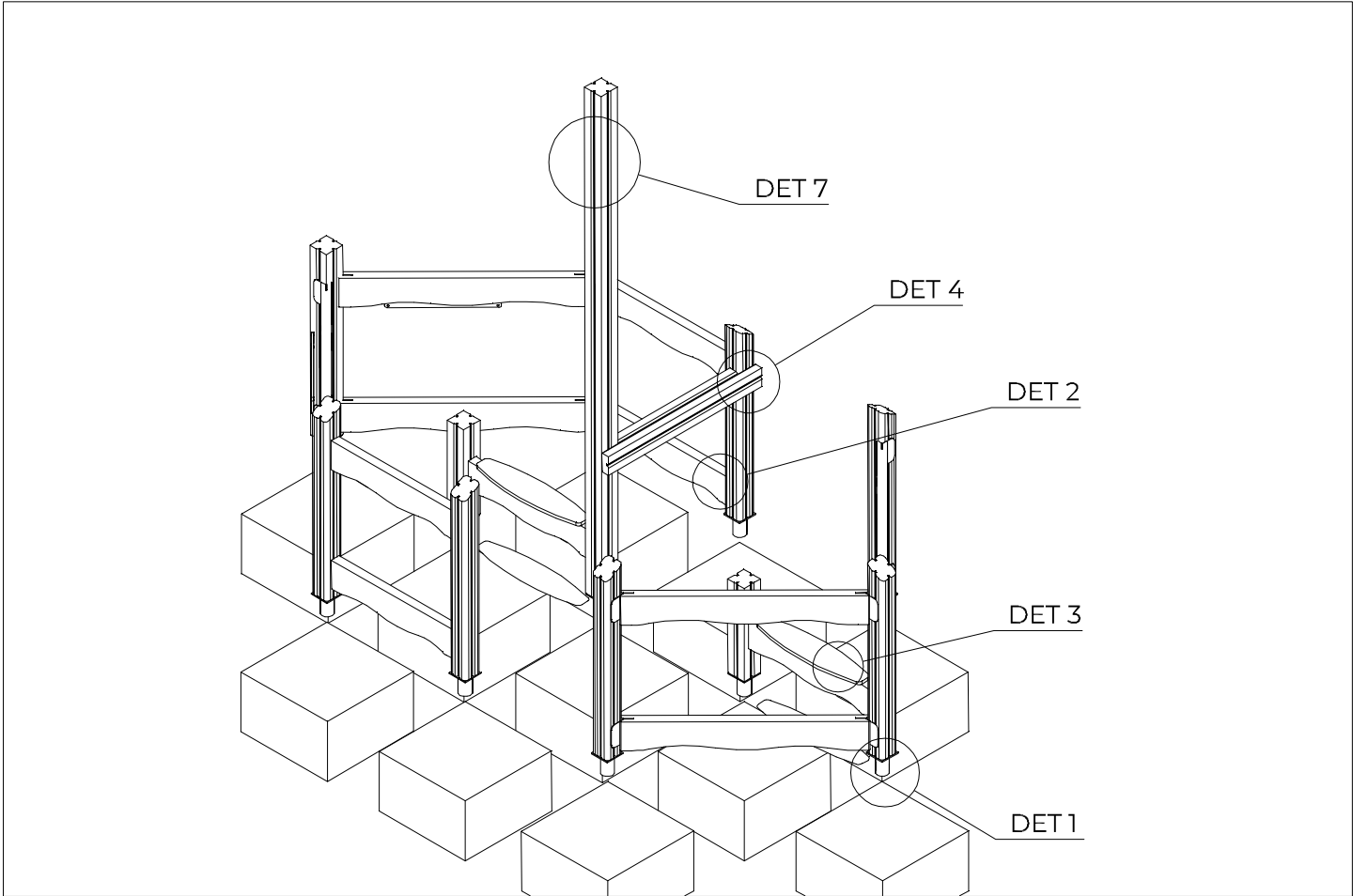

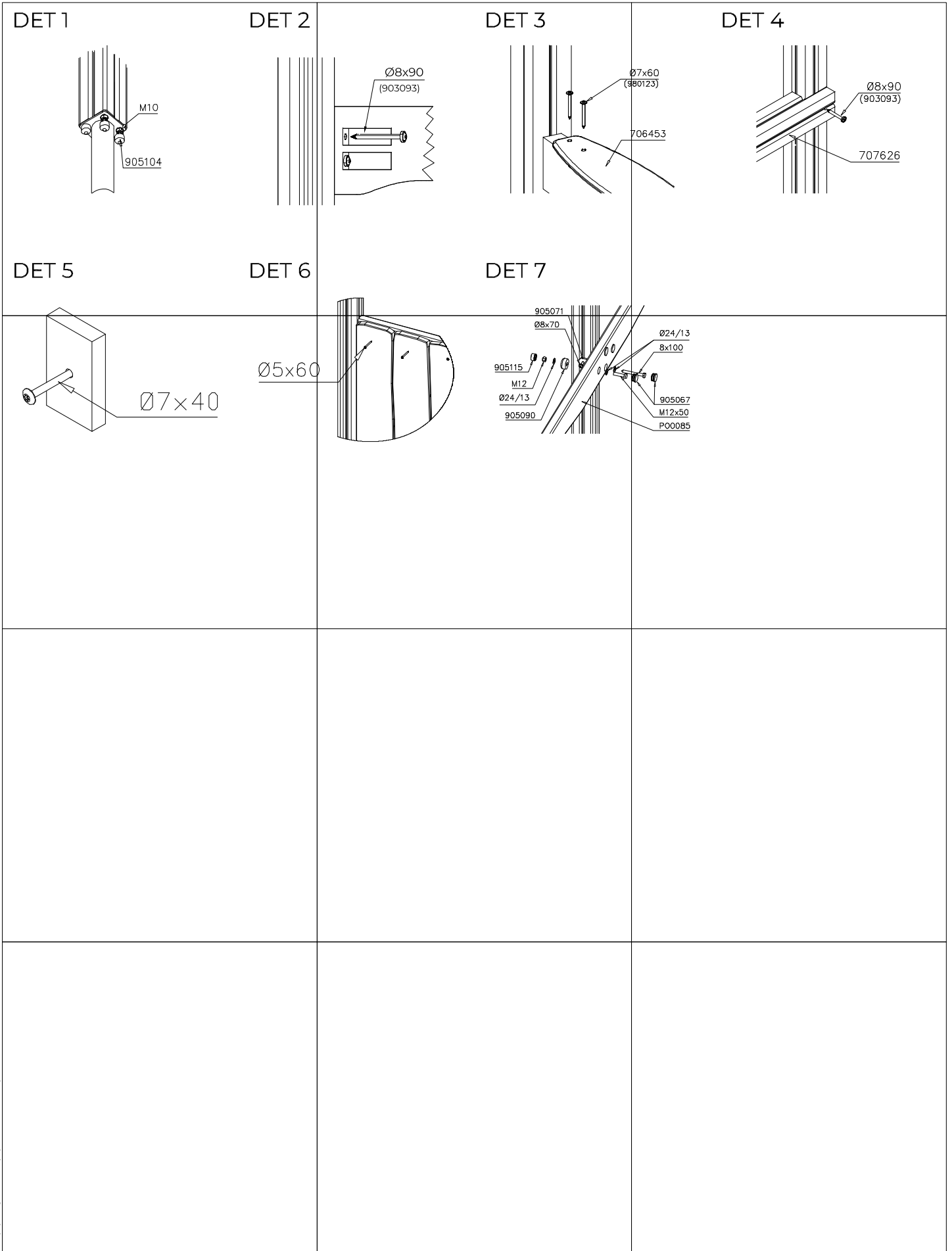

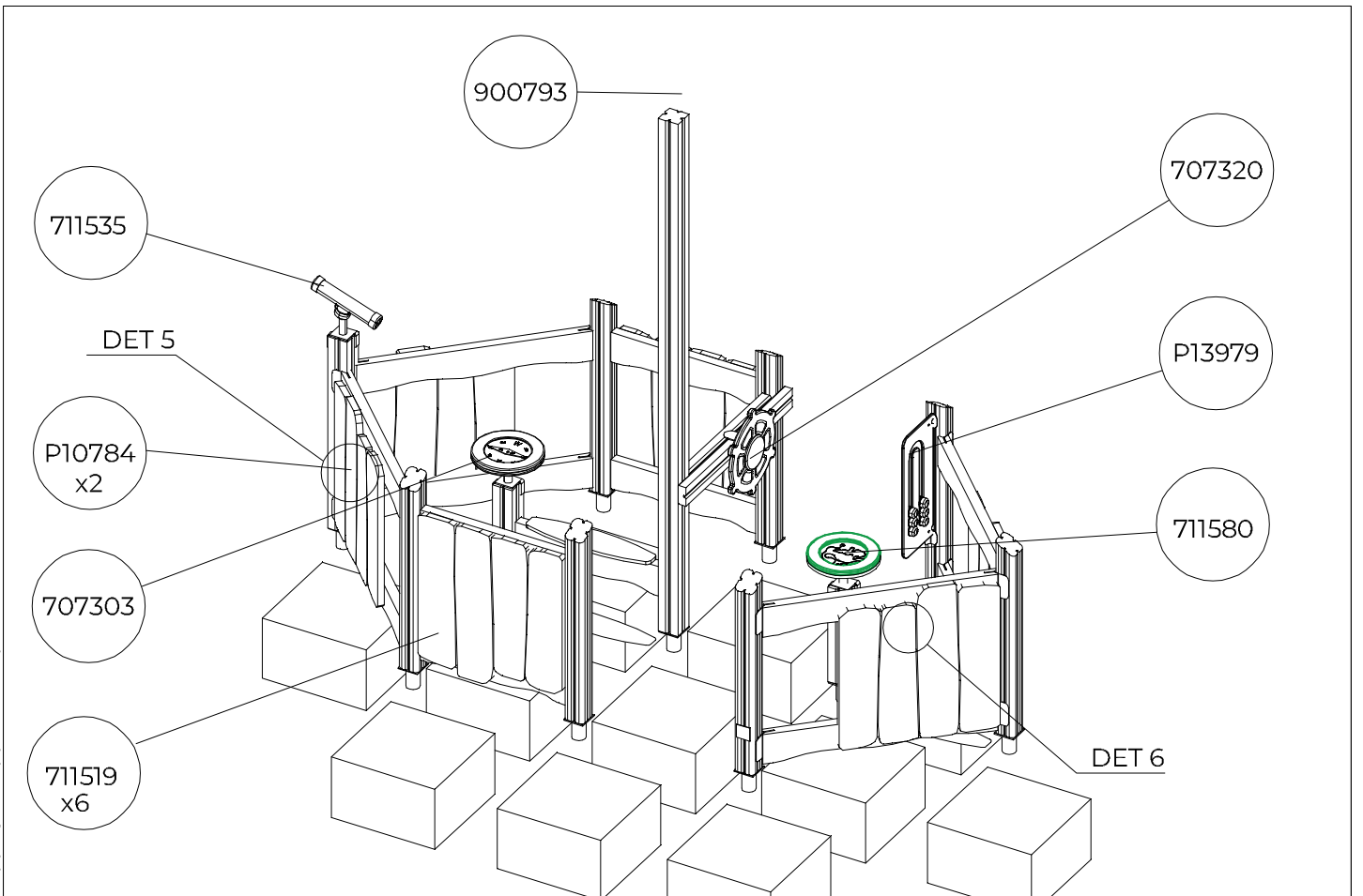
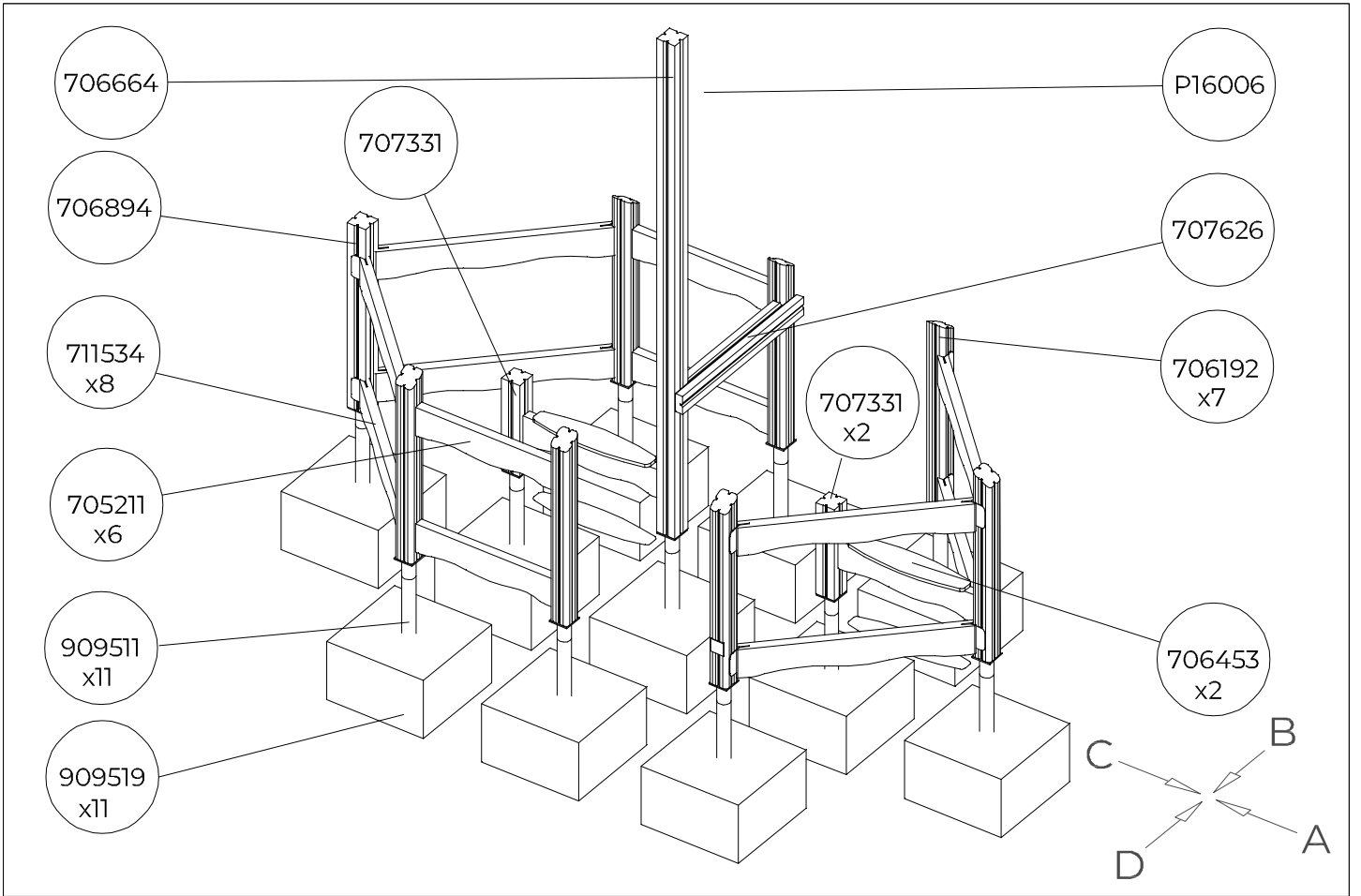

1:50

A

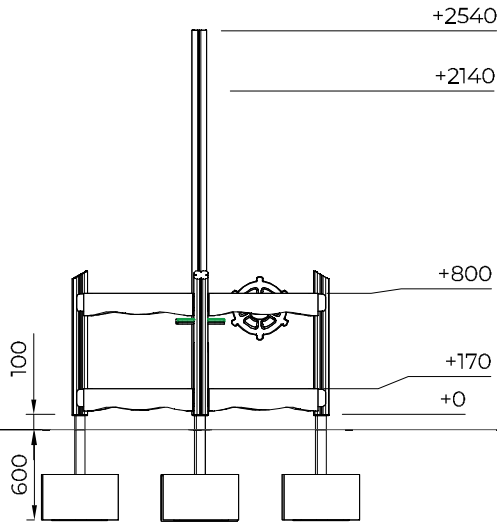

B

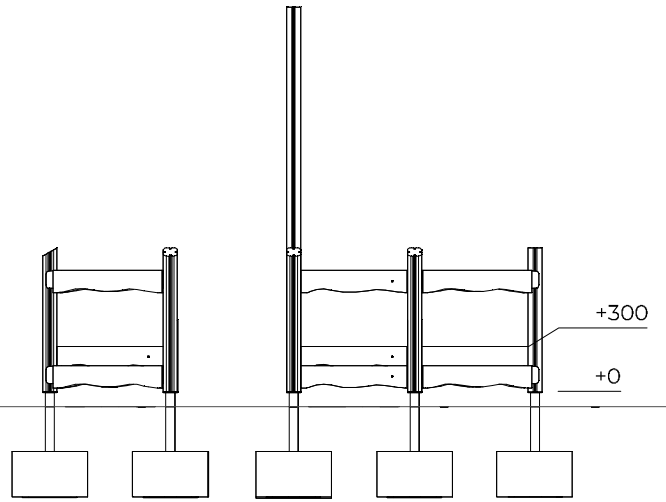

C

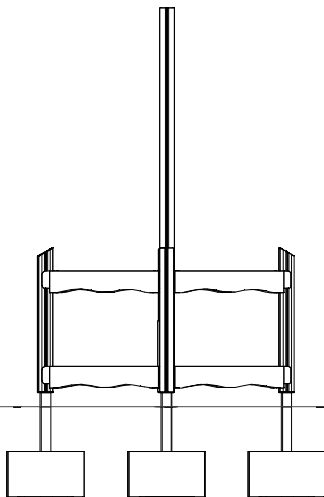

D

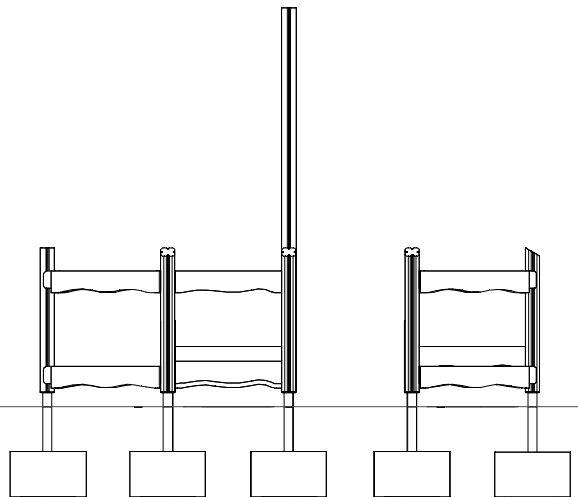

Max Falling Height 420mm

